



BLUEPRINT

FOR

AUTONOMOUS

URBANISM

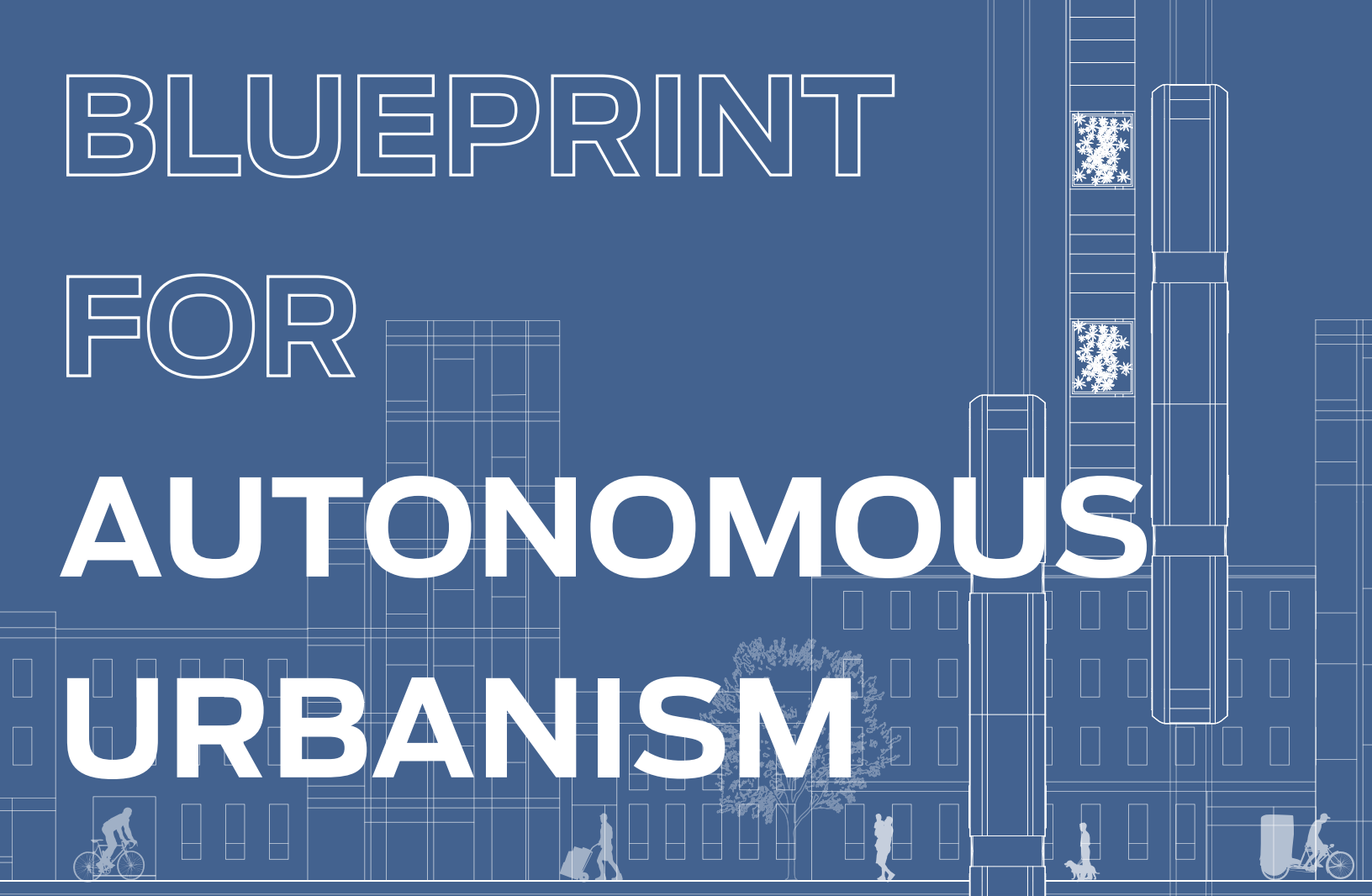

Second Edition





National Association of City Transportation Officials

120 Park Ave, 21st Floor
New York, NY 10017

www.nacto.org

ABOUT NACTO

NACTO's mission is to build cities as places for people, with safe, sustainable, accessible and equitable transportation choices that support a strong economy and vibrant quality of life.

The National Association of City Transportation Officials is a 501(c)(3) nonprofit association that represents large cities on transportation issues of local, regional, and national significance. The organization facilitates the exchange of transportation ideas, insights, and best practices among large cities, while fostering a cooperative approach to key issues facing cities and metropolitan areas. As a coalition of city transportation departments, NACTO is committed to raising the state of practice for street design and transportation by building a common vision, sharing data, peer-to-peer exchange in workshops and conferences, and regular communication among member cities.

NACTO PROJECT TEAM

Corinne Kisner
Executive Director

Kate Fillin-Yeh
Strategy Director

Sindhu Bharadwaj
Policy Associate

Celine Schmidt
Design Associate

Majed Abdulsamad
Program Associate

Alex Engel
Program Manager, Communications

NACTO MEMBER CITIES

Atlanta
Austin
Baltimore
Boston
Charlotte
Chicago
Columbus
Dallas
Denver
Detroit
Houston
Los Angeles
Minneapolis
New York
Orlando
Philadelphia
Phoenix
Pittsburgh
Portland
Sacramento
San Antonio
San Francisco
San José
Seattle
Washington, DC

INTERNATIONAL MEMBERS

Halifax, NS
Hamilton, ON
Montréal, QC
Toronto, ON
Vancouver, BC

TRANSIT AFFILIATE MEMBERS

CARTA
Chicago Transit Authority
Houston METRO
King County Metro Transit
Minneapolis/St. Paul Metro Transit
Los Angeles Metro
Miami-Dade County
Portland TriMet
Vancouver TransLink
VIA Metropolitan Transit

AFFILIATE MEMBERS

Alexandria, VA
Arlington, VA
Bellevue, WA
Boulder, CO
Burlington, CT
Cambridge, MA
Charleston, SC
Chattanooga, TN
Cincinnati, OH
Cupertino, CA
El Paso, TX
Fort Collins, CO
Fort Lauderdale, FL
Grand Rapids, MI
Harrisburg, PA
Hoboken, NJ
Honolulu, HI
Indianapolis, IN
Long Beach, CA
Louisville, KY
Madison, WI
Memphis, TN
Miami Beach, FL
Nashville, TN
New Haven, CT
New Orleans, LA
Oakland, CA
Palo Alto, CA
Pasadena, CA
Raleigh, NC
Salt Lake City, UT
San Luis Obispo, CA
Santa Monica, CA
Somerville, MA
St. Louis, MO
Tampa, FL
Tucson, AZ
Vancouver, WA
Ventura, CA
West Hollywood, CA
West Palm Beach, FL

LETTER FROM THE CHAIR

The autonomous revolution will be humanized.

A century ago, the automotive age swept across the nation, and cities responded not by adapting cars and trucks to the varied uses of the street, but with a relentless clearcutting of obstacles from curb to curb—including pedestrians—and all but eliminating street life.

Subsequent generations of urban planners built upon this, hollowing out downtown urban cores and rebuilding them with congestion and traffic danger, replacing housing with parking lots, and eviscerating surface transit and urban economies. Today, as we enter the third decade of the 21st century, and as we anticipate the arrival of self-driving vehicles on city streets, we have a historic opportunity to reclaim the street and correct these mistakes. This course correction starts with a plan.

The *Blueprint for Autonomous Urbanism* is centered on people and restoring life to our streets—showing how to adapt new mobility technologies to our cities instead of the other way around. If technology can help us redesign streets to meet needs beyond moving cars, they start to look very different. Curbsides promote commerce and shared mobility and are priced accordingly. Vehicle travel lanes occupy only as much road space as they need to move people efficiently so they are not saturated with thousands of single-occupancy vehicles. And a greater proportion of the street space is dedicated to the kinds of mobility that really make our cities move: public transit, walking, biking and shared rides. Remapping the street will also require putting freight in its place so it can fulfill its vital commercial role more safely and efficiently.

The Blueprint looks to the autonomous future as a chance to revolutionize the street for everyone who uses it, and not just a revolution in the technology that runs on it.



Janette Sadik-Khan

NACTO BOARD

Janette Sadik-Khan, Chair
Principal, Bloomberg Associates

Seleta Reynolds, President
General Manager, Los Angeles
Department of Transportation

Robin Hutcherson, Vice President
Director, Minneapolis Department
of Public Works

Michael Carroll, Secretary
Deputy Managing Director, Office of
Transportation
and Infrastructure Systems, City of
Philadelphia

Robert Spillar, Treasurer
Director of Transportation, City of Austin

Joseph Barr, Affiliate Member
Representative
Director, Traffic, Parking, &
Transportation,
City of Cambridge

ACKNOWLEDGEMENTS

NACTO would like to thank Bloomberg Philanthropies and the ClimateWorks Foundation for their support of this important work that will prepare city streets for the future. NACTO also thanks David Vega-Barachowitz and Ben Gillies for contributing to this publication.

CITY REVIEWERS

City of Boston
Kris Carter, Co-Chair, Mayor's Office of
New Urban Mechanics

City of Chattanooga
Kevin Comstock, Smart City Director

Chicago Transit Authority
Emily Drexler, Strategic Planner

District Department of Transportation
Anthony Cassillo, Policy Analyst

King County Metro
Jean Paul Velez, Innovative Mobility
Program Manager

Minneapolis Department of Public
Works
Jon Wertjes, Director of Traffic &
Parking Services
Joshua Johnson, Advanced Mobility
Manager

City of Philadelphia
Richard Montanez, Deputy
Commissioner of Transportation

City of Pittsburgh
Tosh Chambers, Policy Analyst

Salt Lake City Transportation Division
Julianne Sabula, Transit Program
Manager

San Francisco Municipal
Transportation Agency
Katie Angotti, Principal Policy
Analyst
Julia M. C. Friedlander, Senior Policy
Advisor: Autonomous Vehicles
Becca Homa, Senior Transportation
Planner
Hank Willson, Parking Policy
Manager

San Jose Department of
Transportation
Ramses Madou, Division Manager:
Planning, Policy, and Sustainability

Seattle Department of
Transportation
Shannon Walker, New Mobility
Strategic Advisor

TransLink
Andrew Devlin, Manager, Policy
Development
Andrew McCurran, Director, Strategic
Planning and Policy
Niklas Kviselius, Manager, New
Mobility

City of Vancouver
Joanna Clark, Citywide
Transportation Planner

Table of Contents

0.0 Introduction **6**

Foreword to the Second Edition6

About this Document.....7

1

Shaping the Autonomous Future Today

1.1 The Role for Cities **10**

What Does It Take to Move 10,000 People
Per Hour?.....14

Principles for Autonomous Urbanism.....16

Principles of the Future Street.....18

How AVs Could Help or Hurt Cities20

1.2 Levels of Automation **22**

How AVs Work.....24

1.3 Local Action in the Face of Uncertainty **26**

Actions for City Council and Departments.....28

The Division of Regulatory Powers.....34

2 Policies to Shape the Autonomous Age

2.1 Transit	46
Transit Moves More People, Faster.....	48
The Bus of Tomorrow.....	50
The Bus Stop of Tomorrow.....	51
Transit, Labor, and Automation.....	52
Network Planning for the Autonomous Bus	54
2.2 Pricing	58
Types of Congestion Pricing.....	60
A Short History of Cordon Pricing.....	62
How Much to Charge.....	63
Pricing for Equity.....	64
From Ride-Hail to AVs.....	64
Congestion Pricing Case Studies	66
2.3 Data	70
Defining Transportation Data.....	70
The Worldwide Street.....	72
The Path of Journey Data.....	74
The Challenge of Journey Data and Privacy.....	76
Data Anonymization Methods.....	77
2.4 Urban Freight	79
Freight Opportunities in the Age of AVs.....	82
Labor in the Age of AVs	84
Human-Scaled Freight	85
The Future of the Curb.....	86
The Challenge of Micro-Freight Devices	87

3 Design for the Autonomous Age

3.1 Streets for Safety	91
Managing the Future Street.....	94
Dynamics of the Future Street.....	96
New Rules of the Road	98
Safe, Frequent Crossings.....	100
Crossing the Street.....	102
Cycling Through Intersections.....	104
Street Types.....	106
3.2 Curbs for Access	115
Zones of the Future Street.....	118
The Flex Zone.....	119
Coding the Curb.....	120
<hr/>	
4.0 References & Resources	122

Foreword to the Second Edition

Since the publication of the first edition of the *Blueprint for Autonomous Urbanism* in 2017, the landscape of automated vehicle policy and technology has evolved considerably. The cautious optimism that characterized the *Blueprint's* first edition has been tempered by recognition of the enormity of the policy foundation that must be laid for us to reach a human-focused autonomous future.

Like the first *Blueprint*, this edition lays out a vision for how autonomous vehicles, and technology more broadly, can work in service of safe, sustainable, equitable, vibrant cities. This vision builds on and reinforces the past decade of transformative city transportation practice. It prioritizes people walking, biking, rolling, and taking transit, putting people at the center of urban life and street design, while taking advantage of new technologies in order to reduce carbon emissions, decrease traffic fatalities, and increase economic opportunities.

Unique to the second edition is the urgent focus on policies that prioritize efficiency and equity. Increasingly, policy makers are realizing that merely shifting from current to autonomous technologies will not be enough to address the climate and safety challenges that we face or to address long-standing racial and socio-economic inequities. Instead, the autonomous future must be guided by thoughtful, bold, transformative public policy and street design practice that reduces driving and vehicle miles traveled (VMT) and offers mobility and opportunity to everyone, not just those in cars.

At the core of the *Blueprint* is the fact that automation without a comprehensive overhaul of how our streets are designed, allocated, and shared will not result in substantive safety, sustainability, or equity gains. To this end, this edition focuses on four key policy areas—transit, freight, pricing, and data—that form the bedrock of a sustainable, vibrant future. Written by and for cities, the second edition of the *Blueprint for Autonomous Urbanism* charts a path that cities and policy makers can embark upon today to achieve our vision for tomorrow.

About This Document

This edition of the *Blueprint* is organized into three parts, taking the reader through the principles and political structures that underscore and shape our vision of the future, key policy choices around transit, pricing, freight, and data that can reshape our cities, and finally, exploring the sweeping vision for city streets of the future.



Shaping the Autonomous Future Today

The future will depend on decisions we make today. What are the values that underscore our vision of the future? What is the status of technology and where could intentions collide with reality? How can cities leverage the powers at their disposal to affect long-term change and influence the shape of the city and the region? What are the challenges that cities may face in working to ensure that an autonomous future always puts people first?



Policies to Shape the Autonomous Age

Transit, pricing, freight, and data management are four key areas where thoughtful AV policies can significantly improve mobility, health, vibrancy, and the quality of life in cities. How can transit be prioritized to shape the autonomous future? How can pricing be used to ensure efficiency and equity? What must be done now to ensure a thriving workforce in an autonomous age? What technologies support sustainable, efficient transit and freight operations?



Design for the Autonomous Age

Cities hold the key to designing a livable autonomous future. How can and should cities design their streets to ensure that AV technologies support a livable, human-centered future? How should we shape our streets and our curbsides today to ensure that we realize the true benefits of AVs tomorrow?

Section 1:

Shaping the Autonomous Future Today

1.1

The Role for Cities

As home to over 80% of the US population, cities have a critical role to play in shaping automated vehicle policy. Our future depends on how well our urban regions connect people to jobs, to housing, to social opportunities and educational institutions, and to livable, vibrant communities. Cities and municipal governments hold many of the policy levers that can ensure that AVs augment the people-centered future we want.

Technological advances must be driven by human-centered values and priorities, translated into thoughtful, bold public policy. To reach a people-focused autonomous future, cities, and government at all levels, must make decisions today that are based on key principles of safety, public good, equity, and sustainability. AV technology must be harnessed to decrease VMT, not to merely make long drives more palatable. City governments must work rapidly to change how street space is designed and allocated before yesterday's values become enshrined in tomorrow's concrete.

AV technology, policy, and roll-out must focus on transit and efficiency. As Earth's ambient temperature approaches the point of no return in global warming models, reducing GHG emissions by prioritizing transit, biking, and walking takes on added urgency. Fixed-route transit, made reliable and appealing through network redesign and transit prioritization policies, is the most efficient transportation mode and also uniquely adaptable to AV technology in the near-term. In prioritizing streets for transit operations, cities can carve out a clear, near-term application for AV technology and take strides today to reduce emissions.

Cities must retain access to data to ensure that transportation and technology policy serves the public good. With much of AV technology still in its infancy, the full benefits and implications of new transportation technologies are still unknown.

Shared AVs could significantly reduce congestion and the need for parking, opening up new options for transit, biking, and walking. However, early research shows that urban ride-hail services (widely thought to be a precursor model for AV fleet services) are increasing congestion, undercutting transit services, and siphoning off the wealthiest riders¹—outcomes all contrary to public sector goals. Other data suggests that, even if customers share half of all their ride-hail trips, those trips in total still add 2.2 miles of travel for each personal automobile mile taken off the road.²

With so much potential and with so much still unknown, cities must have access to data to ensure robust, evidence-driven decision making. However, today, most cities are restricted from accessing information about how ride-hail services and other new transportation service providers impact congestion and VMT, making it difficult to create meaningful policy to address externalities. Cities must act now to build allies in statehouses and Washington to access data and fight off corporate-backed preemption efforts. Legislation that reduces government access to information about how mobility technologies are operating on city streets, or restricts government's ability to manage technology, will only hurt the public.

City governments must work rapidly to change how street space is designed and allocated before yesterday's values become enshrined in tomorrow's concrete.

Transforming the Street

Today

Single-occupancy vehicles (SOV) are prioritized. People taking transit, biking, or walking are forced to compete with personal cars, reducing safety. Transit efficiency decreases, VMT increases.

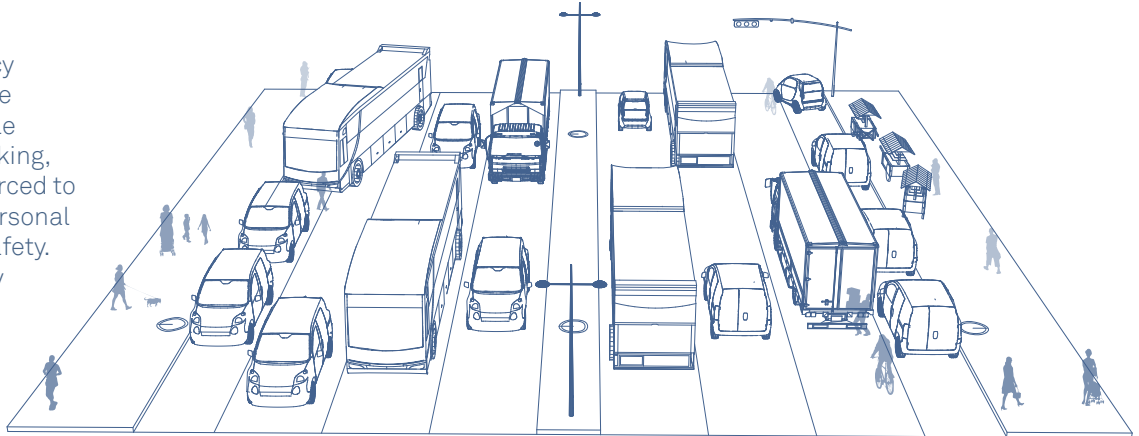

Interim

Cities re-organize their streets to prioritize the most efficient modes, increasing mobility options and safety for everyone. Pricing and transit-priority policies lead to VMT decreases.

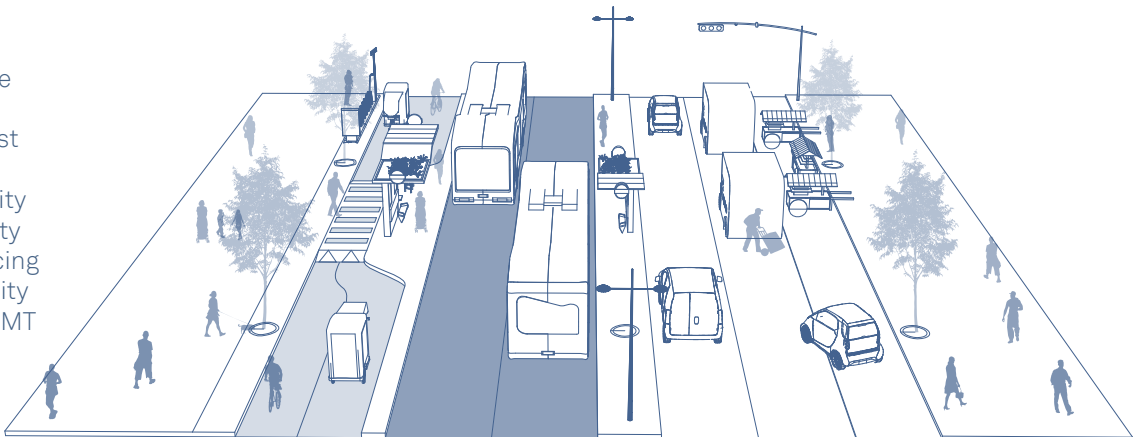

Future

Supported by smart street design, AV technologies enable further reductions in emissions and VMT and improvements in safety.

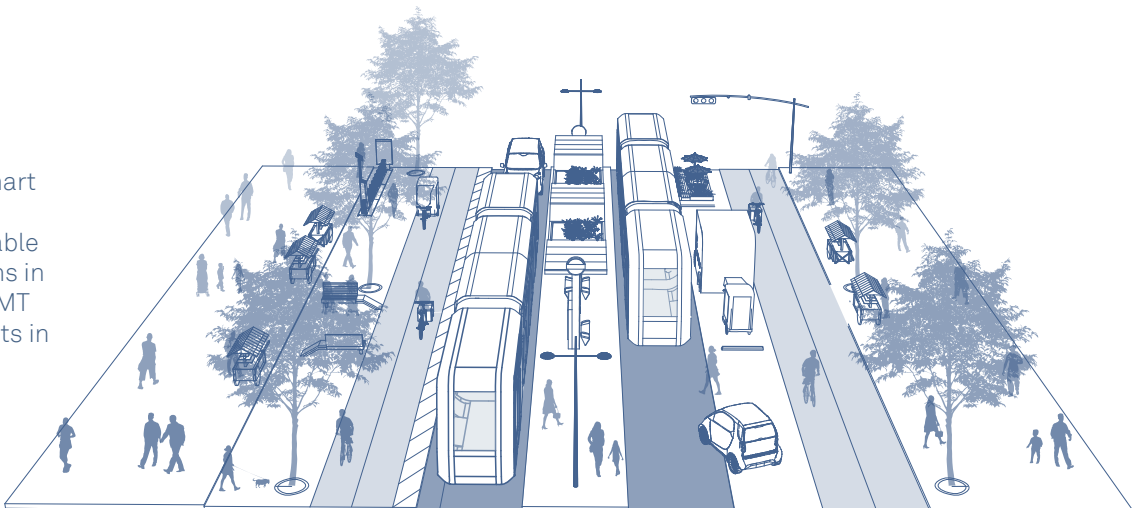

The Role for Cities (continued...)

Safety must remain at the forefront of both public and private-sector decision making. AV technologies could offer significant safety gains for people taking transit, walking, biking, rolling, and driving. To realize these benefits, governments must ensure that the private sector remains fully accountable for the performance of the vehicles they produce. AV technologies that cannot reliably see people of all shapes and sizes in all conditions cannot safely operate on urban streets. Even with AV technology in the driver's seat, vehicle speed will remain the main determinant of fatality or injury; as such, AVs operating in urban areas should be limited to speeds of 25 mph or less. As AV technology develops, cities, states, and the Federal Government must work together closely to ensure that safety, not profit, stays at the fore of decision making.

Changes in land use and policy are essential to ensure that the benefits of AV technology are equitably shared. As cities prepare for automation, land use policy is an important tool to ensure that housing, economic and educational opportunities, and community hubs are connected and accessible. Cities that adopt land use policies that foster dense, affordable, and walkable places will find that their communities and regions will thrive, connected and supported by a wide array of efficient transportation options.

Conversely, land use policies that encourage low-density development will create more congestion and more pollution, even if people aren't behind the wheel. Cities that try to manage growth through ex-urban development will find themselves tied to a shrinking array of unsustainable, inequitable transportation options. In a dispersed, sprawling context, AV technology could exacerbate existing racial and socio-economic inequities, locking lower-income and marginalized people into increasingly long commutes on lower-quality service. Cities must act now to reassess their land use policies and prioritize sustainable, affordable, efficient modes.

Automation offers opportunities and trade-offs for jobs and labor. The advent of AV technology heralds huge shifts in labor markets, a staggering array of new job opportunities, and changes in workforce development needs.

However, without thoughtful workforce development and education policies, technology could exacerbate existing inequalities, further sealing us into a world where zip code determines job options, educational attainment, and life expectancy. Working together, cities, unions, and the private sector must rethink the skills necessary for an autonomous age and start developing policies and job training programs to ensure opportunity for all in this new economy.

AV technology must be harnessed to decrease driving, not to merely make long drives more palatable.

Cities need not, and in fact cannot, wait for AVs to fully materialize to start achieving their safety and sustainability goals. Levels 4 and 5 automation are still under development. In a best case scenario, even if every new vehicle purchased today were fully automated, it would take at least two decades for AVs to make up ninety percent of the vehicles on the road.³ The urgency of our climate crisis and the soaring US traffic fatality rate requires more immediate action.

Regardless of the timing of the autonomous revolution, better street design and land use policy are key to achieving a safe, equitable, sustainable, people-focused future. Decades of experience have shown us that simple, physical changes to street geometry can have huge impacts on safety and how people choose to travel. Our most successful cities and most competitive regions are those that enable residents to move safely, efficiently, and reliably. By redesigning their streets, cities and people will shape technology policy for decades to come.

People come first in the autonomous age.

People walking, biking, rolling, and resting get first priority for street space and resource investments.



Building for **high-capacity on-street transit** is essential for growth without congestion.

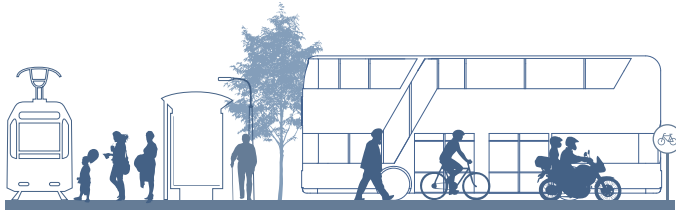

Freight and delivery services are consolidated to increase efficiency. Vehicles are downsized.



Private vehicles and parking are deprioritized.



What Does It Take to Move 10,000 People Per Hour?

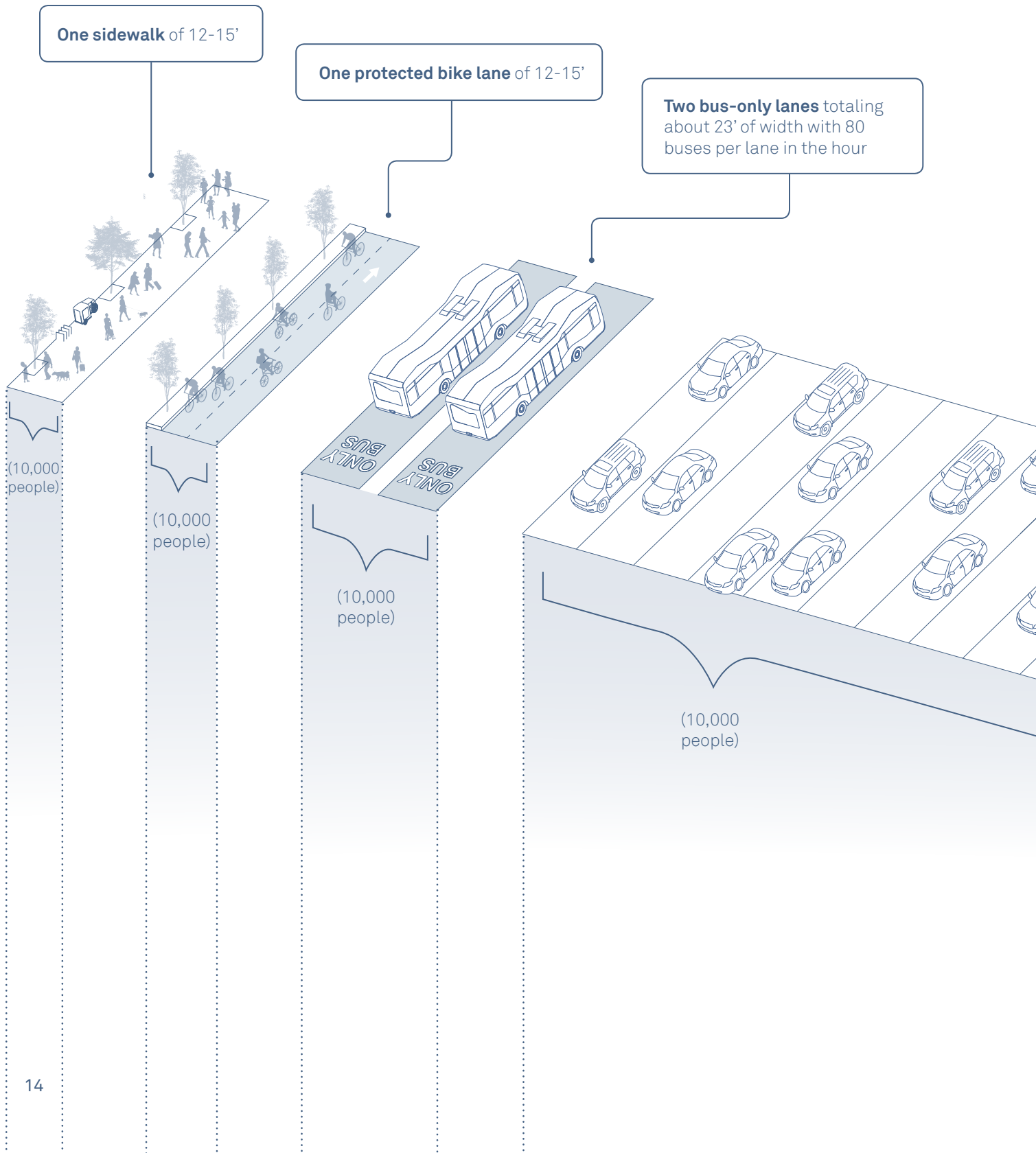

Section 1:

Shaping the Autonomous Future Today

*Uber estimates that its conceptual Uber Air skyports could accommodate 1,000 landings per hour on a footprint of 1 to 2 acres. Assuming four passengers per vehicle, accommodating 10,000 passengers per hour would require a footprint of 2.5 to 5 acres⁴

13 lanes of conventional arterial, with about 800 vehicles traveling through each lane in the hour

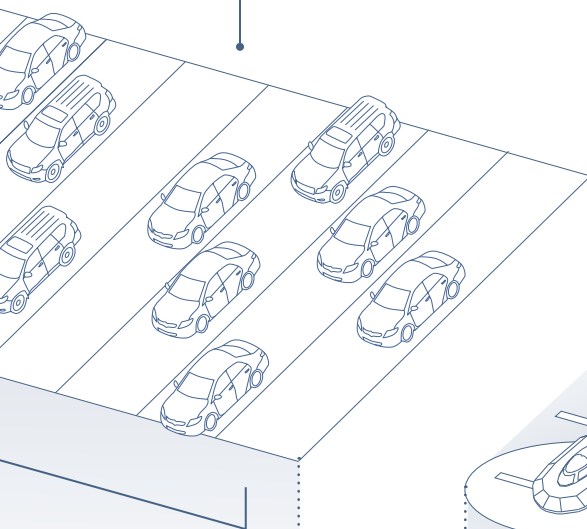

A landing area the width and length of **38 lanes of highway**, with **42 flying vehicles taking off every minute***

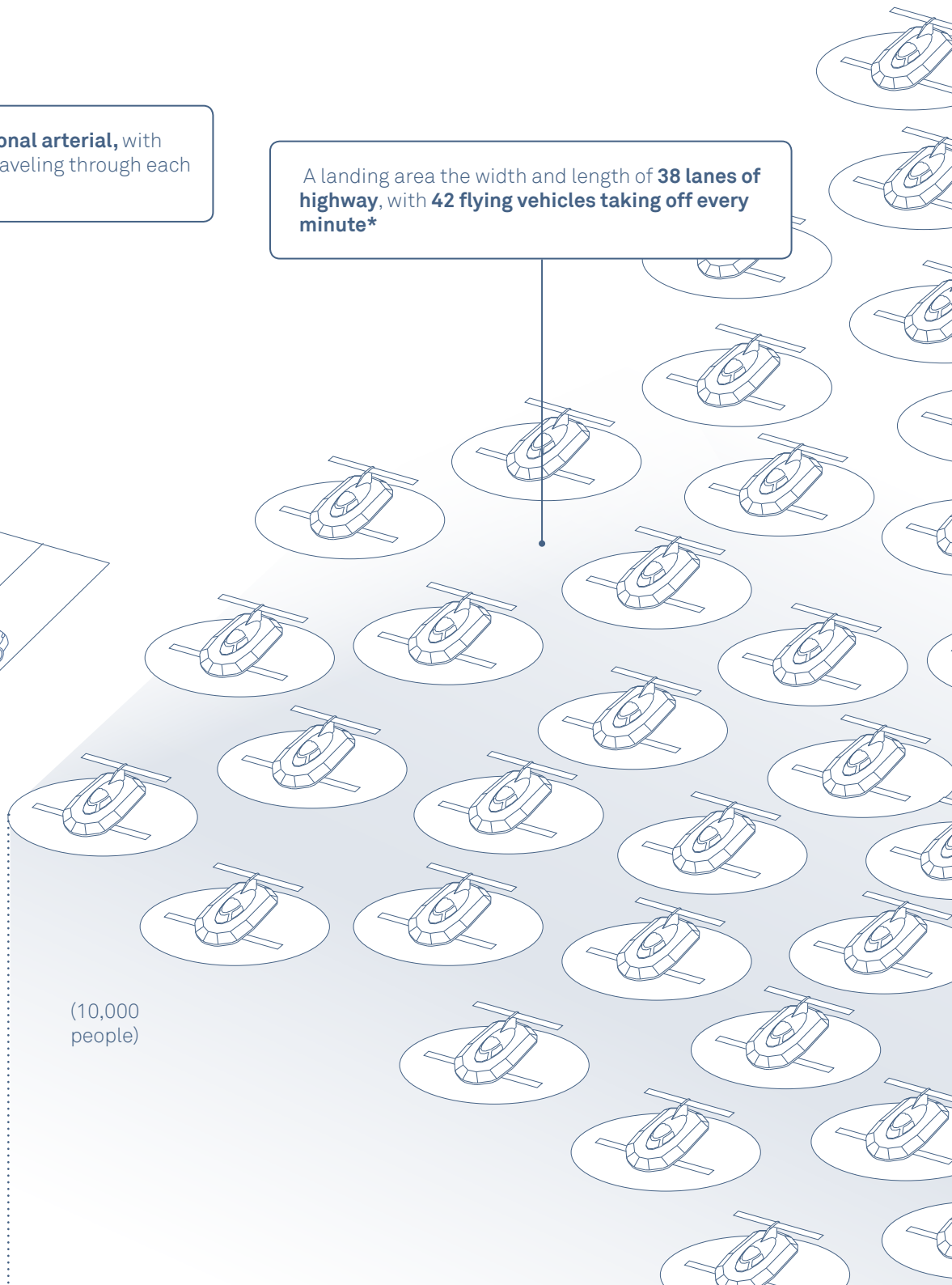

(10,000 people)

Principles for Autonomous Urbanism

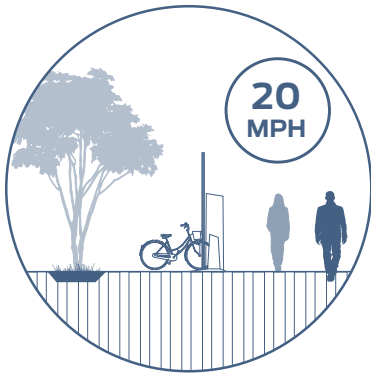

Design for Safety

Street design that prioritizes safety for people walking and biking creates streets that are safer for everyone. Cities must enshrine their values in concrete and policy today, in order to shape a people-focused landscape with AVs tomorrow. With speed as the major factor in the majority of traffic fatalities, cities should design streets that necessitate lower speeds. Automated vehicles should be programmed for low speeds (25 mph or less) on city streets, and programmed to automatically detect and yield to people outside of the vehicle.



Move People Not Cars

If AV technologies focus on private cars and single occupancy vehicles, they will increase congestion and traffic fatalities, exacerbate economic and racial inequalities, and leave us even less equipped to mitigate the impacts of climate change. To avert this dystopian outcome, cities must prioritize the modes that move people efficiently—transit, biking, and walking—by reallocating street space and supporting people-focused street redesigns with smart pricing, curbside management, and data policies.

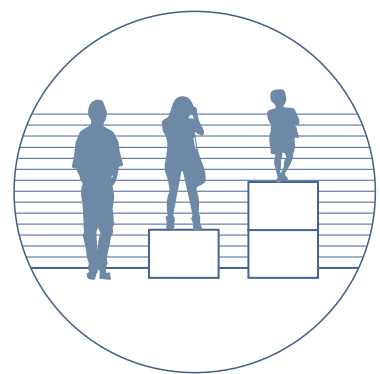

Distribute The Benefits Equitably

Technology offers new tools to address and rectify the structural racial and economic inequalities that limit the potential of people and communities. In policy and practice, cities must consider equity from all angles—access, safety, labor, mobility, affordability, and engagement—and actively ensure that the benefits of automation are shared equitably across cities and communities.



Data-Driven Decision Making

New transportation technologies are generating more data than ever about activity on city streets. To ensure the best outcomes for the public, cities must have information about what is happening on city streets. At the same time, cities must strengthen their ability to push information out to companies and private citizens to nudge their operations towards the public good.



Technology is a Tool

AV and technology policy must be driven by human-centered values and priorities. AVs are not a solution unto themselves, rather they are a tool to achieve better city transportation outcomes. Cities must set policy to maximize the public benefits of technology and lead the transition to a new inclusive and sustainable economy for all.



Act Now!

Cities that are proactive now will ensure the people-focused future they want, with more efficient and sustainable land-use patterns, and redesigned streets for safety and efficiency. Rather than setting public policy based on the limits of technology, or the profit margins of a new industry, cities can proactively ensure that AVs augment city goals.

Principles on the Future Street

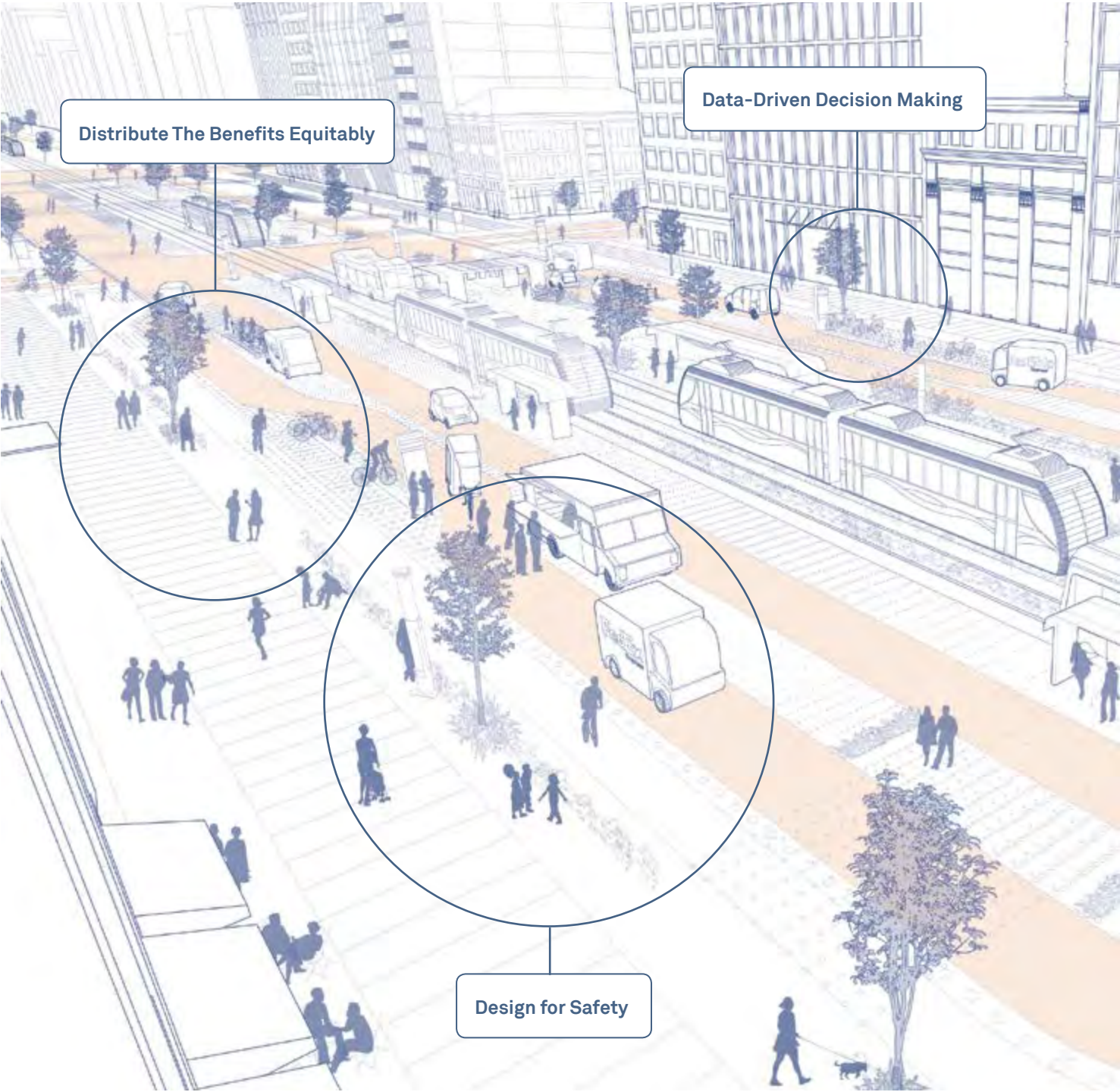



How AVs could Help, or Hurt, Cities

Negative Outcome

Safety	Federal and state governments authorize AVs to operate on public streets before developing objective and verifiable safety performance standards and tests that ensure automated driving prevents injury collisions and fatalities among all right-of-way users. Governments fail to hold companies accountable for fully complying with traffic laws. These failures result in no improvement in today's street safety record while creating new risks and hazards.
Transit	<p>Elected officials demonize transit as inefficient and archaic, state and federal support wanes, systems begin to cut or privatize service, and demand declines. People who rely on transit are increasingly stranded as service deteriorates.</p> <p>Privatized services adopt large-scale loyalty rewards programs, re-stratifying transportation into a system of haves and have-nots, with longer wait times and less convenient routing for those without means.</p>
Pricing	States prohibit congestion pricing so travel remains "free." Due to the low price, many individuals travel more in inefficient vehicles, burdening cities, themselves, and the environment with the negative externalities of unfettered driving.
Privacy	Governments fail to define journey data (e.g., "bread-crumbs" route information, starts/stops, etc.) as personally identifiable information (PII) or to enact comprehensive data protection legislation. As a result, companies and governments alike acquire unprecedented access to the private actions and movements of citizens.
Data	The Federal government determines that private companies control the data automated vehicles generate, reinforcing a business model based on data sales and consumer loyalty. Companies grant 'free' rides in exchange for data (and travel routes that take customers past certain stores).
Freight	High speed platoons of autonomous freight vehicles make roads increasingly dangerous or impassable. In cities, sidewalk bots proliferate, taking away valuable space from pedestrians and cyclists. Delivery drones increase noise in urban areas to unhealthy levels. Unemployment rises as AV-based freight services put people out of work.
Streets	Federal and state officials require dedicated AV lanes, taking street space from other uses. As individuals choose private AVs over transit and travel costs plummet, congestion increases, and pedestrians and cyclists become second-class citizens, relegated to walkways above or below grade for their own safety.
Curbs	States prohibit local governments from regulating private mobility companies, so curbs become increasingly cluttered as companies compete, unimpeded, for space to pick up and drop off passengers.

Positive Outcome

Safety	Federal and state governments adopt objective and verifiable safety performance tests that set a high performance bar that protects all right-of-way users, including those in urban areas. AVs, programmed to travel at 25 mph or less depending on street context, dictate the speed of traffic for all motorized vehicles, reducing the overall speed on urban streets and, as a result, reducing the frequency and severity of crashes. Excess road space, created by slower moving, more efficient AVs, is used to build better, safer places for people walking and on bikes. Safer street design helps cities
Transit	Transit agencies and street departments work together to redesign streets, adopt new technologies, and modernize network planning, making transit faster and more reliable. New technologies, including real-time information, flex-route vans, limited ride-hail services, and integrations of active mobility into transit trips allow transit to cover more of the city, bridging the gap to lower-density places. Trip planning apps and other information/communications tools allow for smarter transit planning and route development. Mobility becomes smarter, while also becoming more equitable and reliable.
Pricing	State and local governments partner to charge a fair price for travel and parking, mitigating congestion and helping to fund a more equitable transportation system.
Privacy	The Federal government passes comprehensive consumer data protection laws, similar to the GDPR in Europe. Cities, states, and the courts define journey data as PII. Governments gain the benefits of increased data for planning and regulation while people preserve their right to control how it will be used and who will see it.
Data	Federal, state, and local regulators require public and private sector actors to share data. Access to more robust mobility data allows governments to make better investments in transportation infrastructure, facilitating balanced, multi-modal transportation.
Freight	Coordinated freight management reduces the number of large vehicles in and around urban areas. Local delivery, which is complex, nuanced, and varied, remains a human job. Freight distribution centers allow the majority of deliveries to take place via e-bikes or other small, high-efficiency modes. Workforce transition plans provide real opportunities for people formerly employed in freight.
Streets	Cities and the private sector together embrace streets as public spaces, fostering design and engineering practices that balance walking, biking, driving, and transit. AV-only lanes are reserved solely for automated mass transit.
Curbs	Cities pass new curbside management plans committing any space savings from reduced parking or lane requirements to public use. Cities use curbside space for parklets, green infrastructure, bus lanes, bike lanes, and small-scale vendors and kiosks.

1.2

Levels of Automation

Autonomous driving technologies are still in their infancy. In order to clarify the possibilities and limitations of these technologies, the National Highway Traffic Safety Administration (NHTSA) and the Society of Automotive Engineers (SAE) have categorized AV systems into five levels, according to their ability to operate in real-world conditions.⁶ Each of the five levels of automation hold different levels of opportunity and risk to people both inside and outside the vehicle.

There are unique challenges inherent in operating autonomous vehicles in cities and urban areas. City streets are complex and unpredictable, populated by large numbers of road users traveling at different speeds, on different modes, and in different directions. As a result, some technologies that have proven benefits in less complex, limited access highway contexts, may not yet be appropriate for urban conditions.

Today

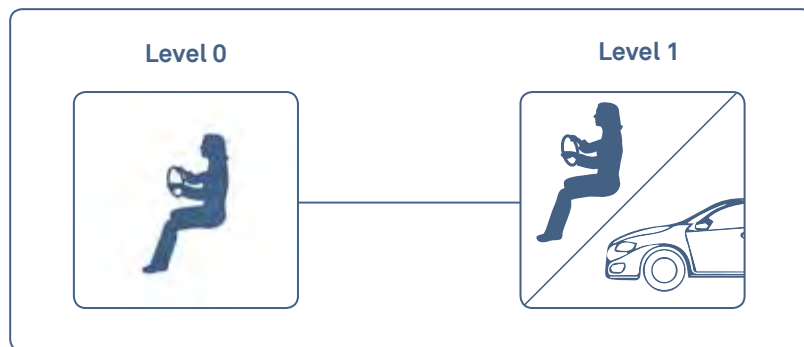

No Automation

The human driver does all the driving.

Driver Assistance

An advanced driver assistance system (ADAS) warns and/or assists a human driver with steering or braking/accelerating. Current examples include adaptive cruise control, forward collision warning, and emergency braking systems.

Emerging

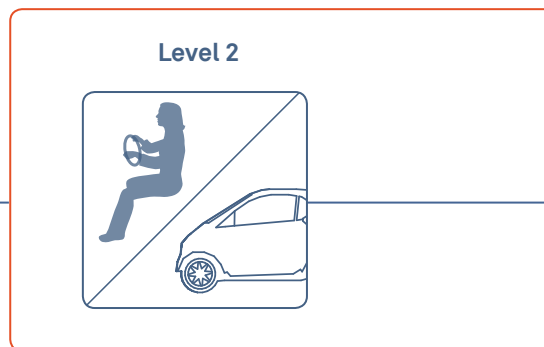

Partial Automation

An advanced driver assistance system (ADAS) controls both steering and braking/accelerating simultaneously. The human driver must continue to pay full attention and be ready to intervene at any time. User manuals for vehicles equipped with these technologies warn users not to use them in city traffic or at intersections.⁵

Dangerous on Urban Streets

Level 2 and **Level 3** systems pose significant risks on city streets because they can lull drivers into complacency and inattention while simultaneously requiring that they be ready to resume full control of the wheel at any moment.⁷ In 2018, in Tempe, AZ, a vehicle operating in Level 3 autonomous mode under the supervision of a trained safety driver hit and killed a woman crossing the street.⁸

Probable Future

Potential Future

Level 3

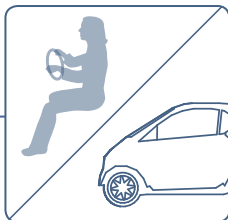

Level 4

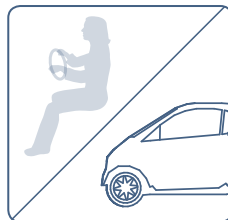

Level 5

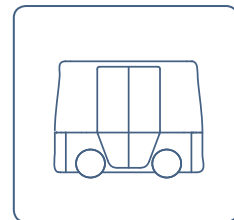

Conditional Automation

An automated driving system (ADS) can perform all aspects of driving under some circumstances (e.g., on a freeway, or in a low-speed traffic jam). The human driver must continue to pay full attention and be ready to intervene at any time, even though the vehicle may appear to be fully driving itself.

High Automation

An automated driving system (ADS) performs all driving tasks with no expectation that a human driver will intervene as long as the vehicle stays within its specific operational design domain (e.g., a mapped geographical area, or within certain weather conditions).

Level 4 technology is still under development and its potential abilities remain uncertain. Key questions remain unresolved, including what a Level 4 vehicle should do upon leaving its operational design domain (e.g., during an unexpected severe weather event).

Full Automation

An automated driving system (ADS) on the vehicle can do all the driving in all circumstances. The human occupants are just passengers and need never be involved in driving. Level 5 technology is still under development and its potential abilities remain uncertain.

How AVs Work

Automated vehicles (AV) interpret their environments using a combination of real-time sensors, GPS signals, and LIDAR data. Using image and pattern recognition software and engineer-assisted training and software development, the promise of AVs is that they will one day be able to accurately detect all people, objects, conditions, and events in the road and react in the safest manner possible, avoiding collisions and improving safety for all users.

AVs use a variety of sensors, advanced software engineering algorithms, and machine-learning to “see” the street, and determine the appropriate path or actions. The decision making process requires an AV to synthesize four types of information to determine its next move and safely navigate towards its destination.

- Location: Where am I located?**
 Sensors must physically match the location of the vehicle with the map and other reference points.
- Perception: What’s around me?**
 Sensors must detect objects of all types and shapes including traffic signals and signs, lane markings, people, and animals.
- Prediction: What’s everyone doing?**
 Advanced engineering algorithms and machine learning tools analyze all data inputs (e.g., location, perception, and dynamic factors like speed, acceleration and direction) to decide what will happen.
- Planning: What should I do next?**
 Building on all inputs, AVs use behavior prediction software to draw from all the sensor information to determine what is the appropriate course of action or path of travel.

As of today, AV technology is still in the development and testing phase. As noted in a recent report on large vehicle design, produced for NACTO by the USDOT Volpe Center, technologies that are precursors to AVs, such as automatic emergency braking or forward collision warning, are incapable of recognizing people in many contexts. These include: people walking in groups, children and people shorter than 3.2 ft., people pushing strollers, wheelchairs, bicycles or other objects, people standing on manhole

covers or steel plates, people carrying things like umbrellas or luggage, in low-light or nighttime conditions, and in adverse weather.⁹

While automated vehicles may eventually surpass human drivers prone to error and distraction, policy makers should be careful to recognize and understand the assumptions and limitations that went into their programming and test their ability to detect objects and events and successfully negotiate complex situations. Just as human drivers must pass a driving test, AVs should be held to high standards of performance and review by public officials charged with protecting the safety of all, especially the most vulnerable road users (e.g., people walking, bicycling, children, and seniors).

Light Detection and Ranging (LIDAR)

Two 360-degree sensors use light beams (millions of laser pulses per second) to determine the distance between the sensor and other objects. LIDAR measures the time it takes for light to reflect off a surface and return. There are three main types of LIDAR for AVs: short, mid and long range. These sensors together provide a surrounding view of their environment to process the objects and events immediately in front or further afield.

Ultrasonic Sensors

Vehicle-mounted sensors provide information about nearby objects. This data is typically used in parking assistance and backup warning systems.

Infrared Sensors

Infrared sensors detect lane markings, pedestrians, bicyclists, and objects that other sensors can find difficult to identify in low light and certain environmental conditions.

Cameras

Cameras mounted on the vehicle identify moving and static objects.

Prebuilt Maps

Prebuilt maps are stored in the vehicle's memory and are often utilized to correct inaccurate positioning due to errors that can occur when using GPS and INS. Given the constraints of mapping every road and drivable surface, relying exclusively on maps can limit the routes an AV can take.

Dedicated Short-Range Communication (DSRC)

Vehicle to Vehicle (V2V) and Vehicle to Infrastructure (V2I) systems send and receive critical data such as road conditions, congestion, crashes, and possibly, rerouting. DSRC enables platooning.

Inertial Navigation Systems (INS)

INS uses gyroscopes and accelerometers to determine vehicle position, orientation, and velocity. INS and GPS are typically used together to improve accuracy.

Global Positioning Systems (GPS)

GPS locates the vehicle by using satellites to triangulate its position. Although improved since the 2000s, GPS is only accurate within several meters.

Radio Detection and Ranging (RADAR)

A sensor that uses radio waves to determine the distance between obstacles and the sensor.

1.3

Local Action in the Face of Uncertainty

Uncertainty frames the future of AVs. In particular, two major sets of questions loom large. First, how will AVs work, especially in cities? Will their safety promises be realized? Second, how will AVs be regulated? Who will have a seat at the table? Who will control the narrative?

One of the biggest promises of AVs is their potential to reduce traffic fatalities. However, this is also one of the biggest areas of uncertainty. The federal government, to date, has largely allowed the AV industry to govern itself on matters of testing and safety. This market-focused approach leaves key safety questions unresolved such as: How will companies determine when a vehicle is considered 'safe'? What authority will cities have in regulating new vehicles on their streets? Should companies be required or allowed to market AVs differently in urban vs limited-access street environments? How will companies be required to program their technology to prioritize the safety of passengers versus the safety of passers-by in the event of a crash or potential crash?

While the initial reports around AVs suggested a rosy safety outlook, recent analyses are more skeptical. NHTSA has retracted its study that suggested that Tesla's Autopilot reduced crashes by 40 percent.¹⁰

Today, cities are the testing grounds for autonomous vehicle technology. As such, strong local authority over AVs is necessary to meet ambitious transportation policy goals.

A recent report by the International Transport Forum found that commercial vehicles operating at level 3 and 4 automation are "unlikely to be able to operate comprehensively in the dense urban environments."¹¹

The second major area of uncertainty is how AVs will be regulated and by whom. Today, cities are the testing grounds for autonomous vehicle technology. As such, strong local authority over AVs is necessary to meet ambitious transportation policy goals. However, a variety of proposed state and federal preemption bills such as the SELF DRIVE Act and the AV START Act threaten cities' ability to be responsive to citizen needs, or in some cases, to access information essential for good policy making or oversight.

In cities and other urban areas, state or federal preemption can pose unique safety risks because it assumes, incorrectly, that urban and rural/suburban streets operate the same. Instead, the volume and diversity of street users, speeds, and modes makes urban streets infinitely more complex than limited-access, rural, or suburban roads. Cities need the power to set contextually appropriate limits and gather information about new modes, especially at a time when the market is rapidly changing and agreed upon conventions are not yet set.

All too often, in creating state or federal level guidelines to govern local conditions, key issues are lost. For example, most federal transportation and design guidelines and regulations are developed for highway driving and rural roads. They require higher speed limits, wider lane widths and larger turning radii. When applied in urban settings and city cores, these highway design standards encourage faster driving and have increased traffic fatalities. To manage both the uncertainty around the safety of AVs and uncertainty around cities' ability to regulate autonomous vehicles on their streets, cities must take action now.

Cities should...

-  **Fight for Their (Rightful) Seat at the Table**

Cities must secure their place at the negotiating table. As individuals and in coalition, cities should monitor Congress and state legislatures to ensure that they don't enact legislation that conflicts with local priorities of improving safety, cutting congestion, and establishing sustainable transportation policies. Collectively, cities represent national majorities of population and economic activity; they can leverage this power to fight for representation on a national level. Engaging elected officials early and often on a shared city perspective on AV policy is and will continue to be crucial in sustaining cities' voices in the debate. City control will be critical in the fight for data from AV companies.
-  **Manage the Message**

City officials can actively shape narratives around automation and need not wait for the private sector to lead the conversation. Cities should reject policy proposals that shift the burden of responsibility from manufacturers to individuals or require cities to build new infrastructure solely to accommodate new technologies. For example, some have suggested AV-only lanes and pedestrian detection beacons as safety measures. However, such proposals will make people less safe by degrading the urban environment, paving the way for platoons of autonomous cars, and prioritizing the least efficient, least sustainable mode of transportation. Cities must keep the focus on people, not technological capabilities, to ensure a people-centered future.
-  **Engage Allies Early**

Automation threatens to disrupt or altogether eliminate millions of jobs in the commercial driving industry. Preventing major negative social outcomes is already a top priority for elected officials. City and labor representatives have a responsibility to engage early and regularly in order to explore and understand the AV issues together, and map out pathways for a "just transition" that will gradually phase disrupted workers into new roles.
-  **Enshrine Priorities in Concrete**

In most cases, the power to change city streets lies firmly in city hands. In the face of uncertainty, cities must leverage all their tools to reshape their streets now in ways that prioritize people and high-efficiency transit, regardless of what the future holds. Physically changing streets today to reduce speeds, encourage bus ridership, walking, and cycling, and create a more welcoming urban realm will increase the likelihood that AVs will be developed as a force for good. Cities can strengthen their hand by using quick-build tools to create political constituencies that support people-focused streets. Similarly, most land use decisions happen at a local level. Changing zoning today to support transit, encourage density, and ensure affordability, will spur development patterns that will shape cities for decades to come.

Actions for City Council and the Departments

A wide array of city departments and government stakeholders play key roles in guiding and shaping AV policy and regulating AV technologies. Cities can accrue the full benefits of AV technology through thoughtful policy coordination and strong communication between these departments and stakeholders. Early action can help cities set the stage today for a successful, sustainable, human-focused autonomous future.



Mayor, City Manager, and City Council

Local political leaders must assess existing and potential technologies by considering how they can support city needs and goals. In budgets and policy, political leaders should focus on the rapid redesign of city streets to prioritize high-efficiency modes like transit, biking, and walking. To ensure positive outcomes, they should engage now with elected officials at the state and federal level to ensure that urban interests are represented.

Potential action items:

- ✓ **Direct transportation and public works departments to build people-focused infrastructure** that can increase transit reliability and convenience, and address safety issues today.
- ✓ **Lobby to shift control over local speed limits to local governments** and authorize the use of active speed-reduction tools, like speed cameras, that are proven to increase safety outcomes.
- ✓ **Establish an interagency working group**, including labor representatives, on shared, connected, electric, and automated mobility to map out action plans for all city agencies to increase safety and plan for adoption of shared, electric vehicles in both the near, and autonomous, futures.
- ✓ **Explore and pursue pricing strategies** to reduce VMT and congestion and better manage curbside demand.

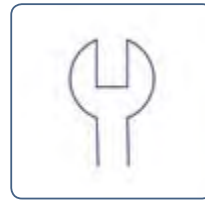

Transportation & Public Works Departments

Transportation departments should focus on redesigning streets to support high-efficiency modes like buses, biking, and walking; revising on-street parking requirements to better manage curb-space usage; and enhancing pedestrian space.

Potential action items:

- ✓ **Take advantage of quick-build tools** to rapidly increase the quality and quantity of transit facilities, protected bike lanes, and pedestrian spaces.
- ✓ **Create a detailed asset map of curbs and curb-side regulations** including loading zones and parking areas for regulatory, maintenance, and management purposes.
- ✓ **Coordinate with Transit Authorities to enhance bus operations** through transit only lanes, transit signal priority, and improved bike/walk connections to transit stops.
- ✓ **Explore curb pricing for commercial and passenger vehicles** to improve safety and efficiency and manage congestion.



Transit Authority

Transit authorities should focus on network redesign, improved communications, and emerging operations tools to increase transit ridership. They should explore electrification options and test new technologies that can enhance service reliability and convenience.

Potential action items:

- ✓ **Coordinate with transportation and public works departments to better designate road space for buses**, increasing the reliability and convenience of service and rebuilding a constituency for transit.
- ✓ **Explore existing and emerging technologies that improve transit service reliability** such as real-time information, off-board fare payment, transit-signal priority, and electrification.
- ✓ **Redesign bus-networks** to prioritize efficiency and reliability and eliminate transfer fees to encourage ridership.
- ✓ **Develop and support digital systems** to better enable regulation, monitoring, management, and planning of transit services.
- ✓ **Establish working group or taskforce that includes labor** and employee representatives to assist in the development of workforce training programs and address concerns and training needs of operations, maintenance, and customer relations staff.



Taxi Commissions

Taxi commissions should develop frameworks to regulate autonomous ride-hail services. They should also work with their counterparts in revenue services, transit, planning, and transportation to determine how regulations can support the City's urban planning, transportation, sustainability, and equity objectives.

Potential action items:

- ✓ **Develop a standard data-sharing agreement** for ride-hail and micro-transit operators.
- ✓ **Evaluate jurisdictional questions and define the scope of the Taxi Commission** over microtransit services, ride-hail services, and other emerging service models.

Actions for City Council and the Departments (continued...)



Parking Authority

Parking and transportation managers should work with the Transportation and Planning departments to create a comprehensive parking strategy for the city, including a plan to gradually remove metered parking, obtain real-time information about on-street parking demand, and assess different future uses for city-owned parking garages.

Potential action items:

- ✓ **Plan to shift from on-street vehicle storage** by developing plans that consider the reuse and reallocation of space devoted to curbside and municipal parking.
- ✓ **Future-proof for reduced parking demand** by creating redevelopment strategies for existing city-owned garages and other developments with required off-street parking.
- ✓ **Explore opportunities for sensor technologies** to better understand on-street parking demand in real-time.



City Planning

Planning departments should adopt policies that encourage efficiency and density to continue promoting the use of transit and active transportation. They should evaluate how automated vehicles might impact sustainability, equity, safety, densification, and transit-oriented development as certain planning assumptions, such as parking minimums, trip generation rates, and loading requirements, will need to evolve as AVs become prevalent.

Potential action items:

- ✓ **Zone for density and affordability** by increasing opportunities for mixed uses; increasing allowable residential FAR, especially around transit; eliminating minimum parking requirements; and using mandates and incentives to address housing affordability.
- ✓ **Eliminate parking minimums** and reassess how loading requirements and trip generation rates will need to change in the lead up to widespread AV adoption.
- ✓ **Promote shared and high capacity mobility** by adopting code that supports complete streets and walkable communities.



Information Technology

Information technology departments must prepare for the enormous datasets that AVs will generate. They should determine what data city agencies will need, and what capacities the city as a whole needs to develop to store, analyze, and protect this information. Data management policies should be updated holistically and routinely to adapt to new data needs and threats. Initially, they will need to work closely with the taxi commission to determine how best to acquire data from ride-hail companies.

Potential action items:

- ✓ **Define journey data as “personally identifiable information”** and ensure that existing policies around data management are appropriate and up-to-date.
- ✓ **Determine current data storage requirements** and capabilities to inform an understanding of future needs.
- ✓ **Explore cybersecurity concerns and privacy protocols** with sister agencies.
- ✓ **Prioritize open formats** and tools in all development and procurement in order to ensure that cities can take advantage of the best technologies without getting locked into proprietary tools.
- ✓ **Support DOTs in the development of digital systems** to manage assets, enable regulation, monitoring, management, and planning.



Employment and Administrative Services

Labor and workforce professionals should work with the Transportation Departments & Transit Authorities to prepare the workforce for automation and develop a clear understanding of what kinds of jobs can and cannot be automated.

Potential action items:

- ✓ **Conduct a citywide assessment of how AVs could impact existing and future jobs** with an emphasis on the effects a labor transition would have on communities of color, immigrants, and refugees.
- ✓ **Develop workforce development strategies** for transit and freight drivers and other professions that may be impacted by AVs.
- ✓ **Overhaul city and transit agencies' hiring practices** and exams to bring in a more nimble and diverse workforce and develop on-going training programs to ensure all employees, existing and future, are ready for the challenges and opportunities ahead.

Actions for City Council and the Departments (continued...)



Sustainability, Energy, and Environment

Sustainability offices and related agencies should begin planning and implementing charging infrastructure for municipal fleet vehicles. They can also work with Transit Authorities, City Planning, and Revenue Services departments to determine Electric Vehicle Supply Equipment (EVSE) siting strategies and adoption plans.

Potential action items:

- ✓ **Develop strategies for allowing companies to site EVSE infrastructure**, considering potential impacts on the energy grid.
- ✓ **Quantify the positive and negative environmental impacts of AVs**, considering the development of regional transportation and energy models.



Fleet Service

Fleet services, including paratransit, should explore opportunities to transition fleets to smaller electric service vehicles, especially for fire, police, and maintenance services.

Potential action items:

- ✓ **Explore opportunities to introduce existing and emerging safety technologies**, such as speed governors, on all fleet vehicles.
- ✓ **Develop fleet transition plans** to identify opportunities for electric vehicles and AVs.
- ✓ **Explore opportunities to right-size fleet vehicles**, focusing on procuring and using the smallest appropriate vehicle for the job, and adopting Direct-Vision standards for all large vehicles.



Police & Fire

First responders must consider how automated vehicles may impact operations. Agencies must inform themselves on how automation might impact risks of terrorism or cyberattack, and coordinate with other agencies to reduce risks and take advantage of opportunities posed by autonomous vehicles.

Potential action items:

- ✓ **Engage with transportation and technology experts** to develop understanding of AV technologies, explore the implications of converting fleets to AVs, and train first responders on AV technology.
- ✓ **Coordinate with transportation and public works departments to use street design to enforce slower vehicle speeds** and increase pedestrian/bike/transit-only space in downtown areas to reduce risk and lethality of autonomous vehicle-as-weapon attacks.
- ✓ **Develop in-house expertise on cybersecurity threats** that could remotely access vehicle data and controls.



Revenue & Budget Services

Revenue, budget, and finance departments should undertake a comprehensive analysis of how revenue sources may change with automation and supporting policies. In particular, they should explore opportunities for pricing public goods and city assets to support city policies around sustainability, equity, and efficiency.

Potential action items:

- ✓ **Document the revenues impacted** by AV adoption and assess strategies for offsetting those losses.
- ✓ **Create a priority-based framework for pricing** that encourages high-efficiency and sustainable modes while sending price signals to discourage inefficient, single-occupancy vehicle travel.
- ✓ **Support city efforts to explore and pursue pricing strategies** to reduce VMT and congestion and better manage curbside demand.

The Division of Regulatory Powers

Historically in the US, the Federal Government has held the authority to regulate vehicles and products, while states, through their Departments of Motor Vehicles and license requirements, have presided over regulation and qualifications for the driver. In other words, the Federal Government has traditionally assumed the responsibility for ensuring that the vehicle performs as required, while the states address individual safety by creating rules around what skills are necessary to be allowed to drive.

AVs complicate the historical division of regulatory authority because the vehicle is the driver. As a result, the traditional role of states—determining what skills are necessary to be allowed to drive—may be supplanted by the federal prerogative to decide what features and abilities AVs need in order to operate in the public right-of-way. In turn, cities, which traditionally hold sway over local issues such as curbside regulations, face the potential of being preempted by their states, which may seek to control where AVs can go.

The questions around regulatory authority grow even more complicated as companies, competing to market new technologies first, lobby at the federal level to expand options to test and deploy self-driving technologies on city streets populated by real people. Since 2016, USDOT has adopted an increasingly hands-off approach to oversight of AV technologies, relying on companies to adhere to voluntary technical standards.¹²

In efforts to exercise influence over AV policy, especially on city streets, local governments have attempted to establish frameworks for AV testing and developing standards for data sharing between private companies and local governments. In response, there has been considerable effort from companies to pass federal legislation preempting cities from regulating and managing autonomous technologies.¹³

The Federal Perspective

To date, USDOT has taken a market-driven approach to the regulation of AV technologies. USDOT supports voluntary technical standards and strongly encourages local governments to seek assistance from “industry associations, private sector consultants, and automation technology developers” to both test vehicles and understand the implications of this technology.¹⁴ The National Highway Traffic Safety Association (NHTSA), a branch of USDOT, has currently only issued a voluntary, twelve-point safety checklist for AV operators and no longer requests safety assessment letters for companies to receive federal approval for testing.¹⁵

In their latest document guiding national AV development, *Preparing for the Future of Transportation: Automated Vehicles 3.0*, USDOT notes that its role in vehicle automation research is to “support the testing and deployment of novel technologies...and the development of voluntary standards that can enable the safe integration of automation.”¹⁶

Traditional & Emerging Areas of Authority

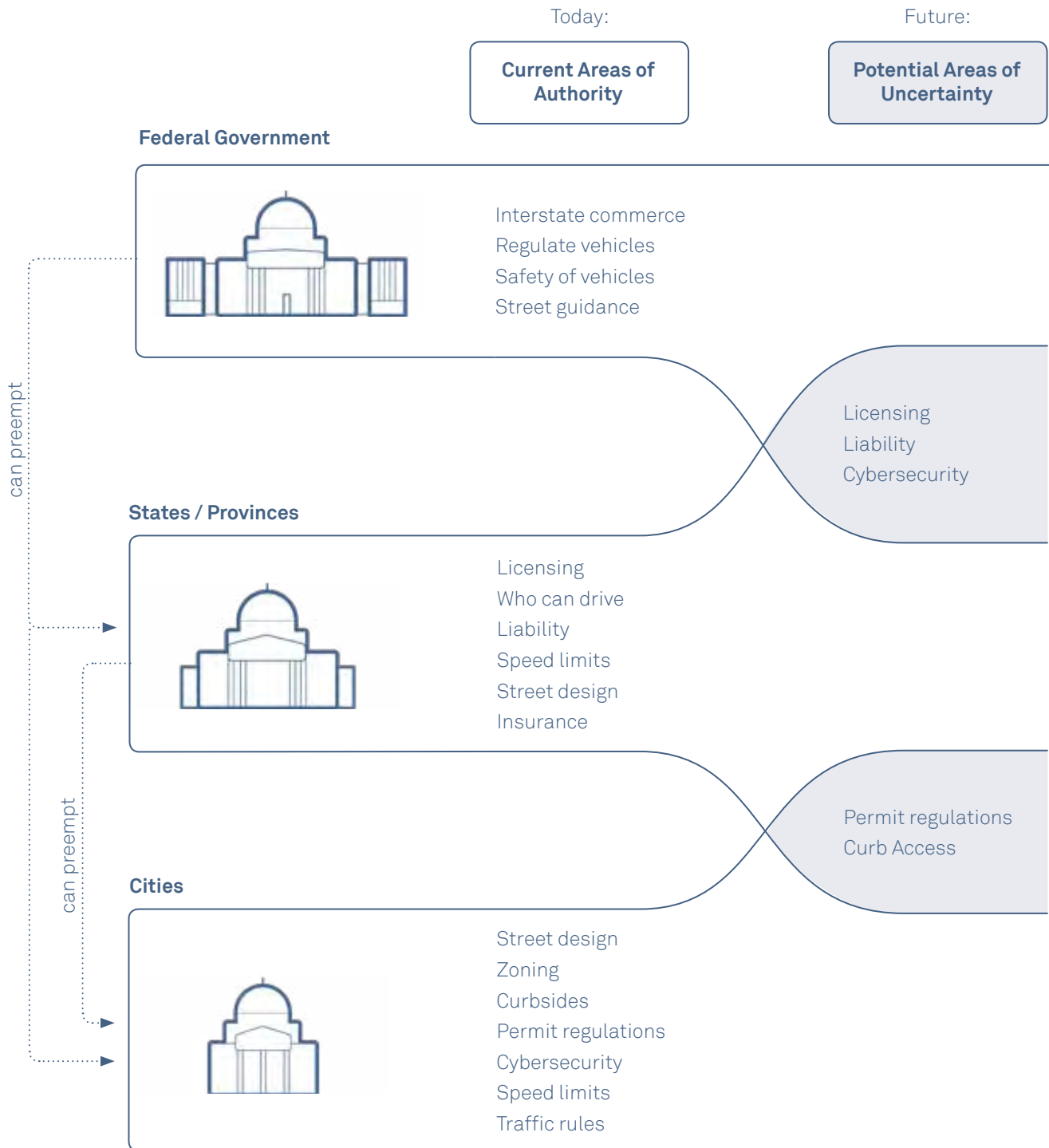

Emerging Issues

As traditional areas of authority continue to shift and evolve between cities, states, and the Federal Government, a number of issues related to safety and access to information will likely come to the fore.



Vehicle Safety

A major anticipated benefit of AV technologies is their potential to reduce traffic crashes, injuries, and fatalities because autonomous vehicles can be programmed to always travel at low speeds that are appropriate in urban areas, and to “see” and avoid people more reliably than human drivers. However, there is still an active debate over who will be responsible for ensuring these safety benefits come to fruition. To date, the Federal Government has largely allowed the AV industry to govern itself on matters of testing and safety. Key safety questions are still unresolved, such as: who will determine when a vehicle is ‘safe’ and what criteria will they use? How will companies be required to program their technology to prioritize the safety of passengers versus the safety of passers-by in the event of a crash or potential crash?

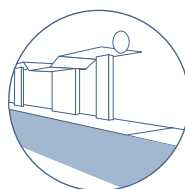

Infrastructure

Cities and states have historically made local decisions about infrastructure design. However, if NHTSA determines that vehicle-to-infrastructure technology falls within its safety jurisdiction, it could seek to become more involved in infrastructure planning and construction. More pessimistically, in a misguided effort to create a uniform landscape in which AVs can easily operate before lidar/sensor/camera technologies are 100 percent reliable, the Federal Government could try to compel cities to redesign streets in ways that prioritize AVs over other modes. AV-only lanes and associated barriers, such as pedestrian or bike gates, over-passes, and under-passes, as well as requirements that pedestrians and cyclists carry detection beacons, would be negative outcomes for people and cities.



Data Privacy and Information Access

Access to the data produced by AVs and other emerging transportation technologies is a particularly contentious topic. Like ride-hail and shared micromobility services today, automated vehicle companies will likely gather vast amounts of potentially personally identifiable data on people's travel behavior. Governments need this aggregate data to ensure safety on public streets and manage and regulate transportation services to best serve public goals. Meanwhile, companies are looking to protect trade secrets and profitability projections in a crowded marketplace. Complicating matters, the US lacks comprehensive consumer privacy protection policies that could guide how data is collected, stored, used, and shared. Already, ride-hail and shared micromobility companies have exploited the lack of clarity around data to lobby states and the Federal Government to limit the ability of local governments to require data reporting. State legislatures and Congress might further restrict what data cities can collect from automated vehicles. On the consumer side, lax federal oversight might even limit what states can require of automakers when it comes to informing consumers as to what data is being gathered and how it is used.



Cybersecurity

Cybersecurity risks raise major questions for AV proliferation. AVs are vulnerable to cyberattacks as hackers and other malicious parties can target the software within AVs or connected vehicle infrastructure to compromise safety. The risks of such attacks are inherently local as the people and infrastructure immediately around compromised vehicles are vulnerable targets. Comprehensively addressing this threat will require the Federal Government to create strong cybersecurity standards for vehicles and hold manufacturers accountable for breaches.

The Threat of Preemption

Preemption of local authority poses unique safety risks to people on city streets and in urban contexts because it limits the ability of local government to be directly responsive to the needs of its people. If federal agencies determine that state or local legal requirements interfere with national regulations, they could employ preemptive authority, in the name of removing “unnecessary” barriers. In “Preparing for the Future of Transportation,” USDOT has already asserted its opposition to “unnecessary or overly prescriptive State requirements that could create unintended barriers for the testing, deployment, and operations of advanced safety technologies.”¹⁷ Cities must coordinate with and monitor congressional and state legislatures to ensure that control over city streets and policies remains at the local level.



Congressional Legislation

Historically, states have had far-reaching responsibility when it comes to mobility. However, congressional legislation could change that. In 2018, the Safely Ensuring Lives Future Deployment and Research In Vehicle Evolution (SELF DRIVE) Act passed the US House of Representatives. The legislation attempted to, “[establish] the federal role in ensuring the safety of highly automated vehicles by encouraging the testing and deployment of such vehicles” and preempt states from enacting more stringent laws than the federal standard.¹⁸ AV START, the Senate version of SELF DRIVE, similarly preempted State and local action on the design, construction, and performance of AVs. AV START ultimately failed to become law, leaving the door open to future federal action.

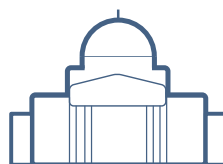

State Legislation

States could also exert authority over how AVs operate on city streets. Ride-hail services provide a good prediction of potential legislative outcomes for AVs. Currently, most local governments oversee ride-hail services through their taxi authorities or commissions. With the advent of app-based ride-hail services, however, many companies lobbied state legislatures to assert control of these technology companies at the state level, in some cases significantly reducing their level of regulation compared to taxi operators.¹⁹ A similar pattern, although less successful to date, emerged in 2017-2018, as dockless bikeshare companies lobbied states to preempt cities’ ability to regulate such programs.^{20, 21, 22}

California Case Study

California provides a unique case study for the conflicts that may emerge with automation. As one of the first states to permit testing, California has revised its AV regulations a number of times over the last few years. The state's latest regulations outline requirements for commercial deployment. Companies intending to operate in California beyond testing must²³:

- Certify the vehicle is equipped with an autonomous vehicle data recorder, the technology is designed to detect and respond to roadway situations in compliance with California Vehicle Code, and the vehicle complies with all Federal Motor Vehicle Safety Standards (FMVSS) or provide evidence of an exemption from NHTSA.
- Certify the vehicle meets current industry standards to help defend against, detect, and respond to cyber-attacks, unauthorized intrusions or false vehicle control commands.

- Certify the manufacturer has conducted test and validation methods and is satisfied the vehicle is safe for deployment on public roads.
- Submit a copy of a law enforcement interaction plan.
- If the vehicle does not require a driver, the manufacturer must also certify to other requirements, including a communication link between the vehicle and a remote operator and the ability to display or transfer vehicle owner or operator information in the event of a collision.

Notably, California leaves the determination of safety up to testing companies and federal regulators. Companies must self-certify that their cars can safely operate without a human, and while they must adhere to federal safety regulations, none currently exist. If other states follow a similar path, it will give significant leeway to federal regulators and the private sector to determine the speed and safety of AV testing and development.



Photo: Wikimedia Commons, Grendelkhan



Photo: Wikimedia Commons, Smiley.toerist (Lyon, France)

2

Policies to Shape the Autonomous Age

2.1 Transit.....	46
2.2 Pricing.....	58
2.3 Data.....	70
2.4 Urban Freight.....	79

Policies for a Thriving City

Today's urban mobility economy is dramatically different than it was five years ago and even more changes are on the horizon. Autonomous vehicle technology could dramatically lower the price of automobile trips, push demand to higher levels, and divert cities' attention away from centering low-carbon and active transportation modes.²⁴ In order to ensure that cities remain vibrant places for people to live, work, and play, cities must proactively pursue policies that harness technology while keeping key principles of efficiency, safety, and human-scale at the core of all decision-making.

By implementing proactive policies today, cities can act to ensure that the adoption of AV technologies improves transportation outcomes rather than leading to an overall increase in driving. As the largest markets for AV technology, cities have an opportunity to prioritize and regulate their existing infrastructure for the benefit of residents and the environment while shaping and scaling strategies to deploy new technologies for the betterment of their streets. By taking action now, cities can make a human-centric autonomous future a reality.

Crafting a truly people-focused autonomous future requires cities to take action today in four key interconnected policy areas:

- 1 **Transit**
- 2 **Pricing**
- 3 **Data**
- 4 **Urban Freight**

Already technologies that are considered precursors to automation are increasing congestion and causing major upheavals in the labor market. To achieve the best potential outcomes of AV technology, cities will need to grapple now with fundamental issues of how we choose to allocate a finite resource—public space in cities. Cities will need to rethink longstanding policies and practices for transit systems, transportation demand, data, and freight distribution in order to manage the impact of this new technology on their streets and leverage it for the improvement of the public realm.



Section 2:

Policies to Shape the Autonomous Age

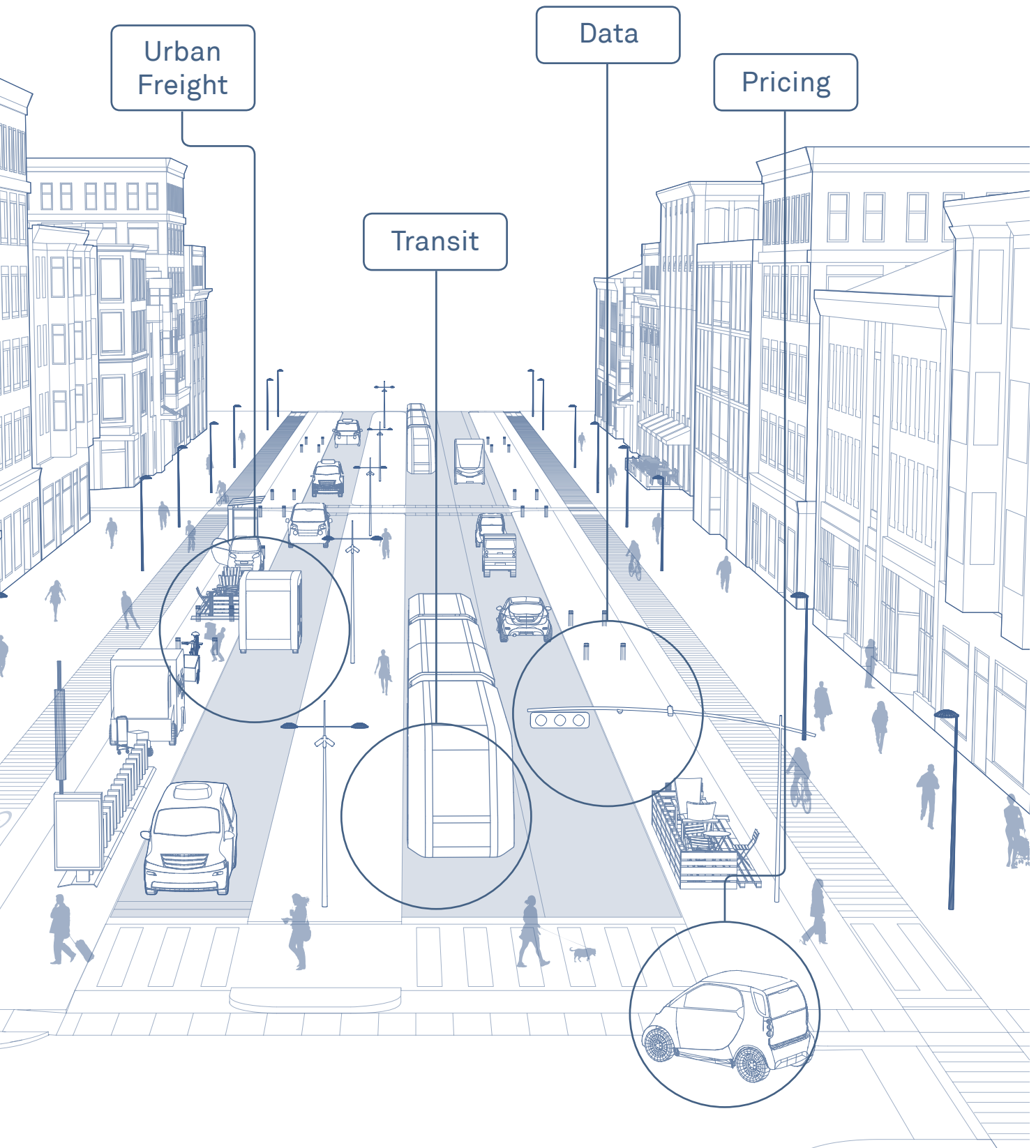



Photo: SFMTA (San Francisco)



2.1

Transit

Transit Moves More People, Faster.....	48
The Bus of Tomorrow.....	50
The Bus Stop of Tomorrow.....	51
Transit, Labor, and Automation.....	52
Network Planning for the Autonomous Bus.....	54

2.1

Transit

Transit is the key to a people-focused autonomous future. Regardless of technological advances, connecting people to each other and to their destinations in dense urban places requires reliable, frequent, high-capacity transportation networks. In focusing on improving bus and rail service today, cities hold the toolbox for accommodating growth without increasing congestion. By coupling transit priority street design, new automation capabilities, and big data streams, cities and transit agencies can unlock opportunities to improve urban mobility. Supported by city-wide pricing policies, like cordon pricing, off-peak delivery hours, and thoughtful, data-driven curbside management, transit can power economies and help more people get where they want to go.

Transit is one policy area where vehicle automation and its precursor technologies can have the most immediate direct impact. Automated technologies are especially suited for predictable, fixed routes. Operators can reduce costs and increase service quantity and quality by shifting or augmenting driving functions with autonomous technology. At the same time, many key safety and “conductor” functions will need to remain in the hands of people, opening up options for productive negotiations with labor unions. With more efficient near-term operations, transit agencies can increase service and serve more riders for the same operating cost. In the long term, full automation can enable agencies to further expand service.

The recent declines in transit ridership in the US underscore the need to invest in transit services today to ensure a sustainable, equitable future. For the past four years, fixed-route ridership has declined in most US cities by roughly 2 percent per year.²⁵ Increasing traffic congestion slows transit, causing riders to shift to using personal vehicles

and ride-hail services. However, as demonstrated in cities like Vancouver, Seattle, Columbus, Toronto, and Austin, when transit is prioritized in street design, ridership increases.²⁶ Red bus lanes, all-door boarding, transit signal priority, and in-lane stops produced travel time gains as high as 23 percent.²⁷ In Toronto, the redesign of King Street led to a 17 percent increase in transit ridership in just one year.²⁸

In focusing on improving bus and rail service today, cities hold the toolbox for accommodating growth without increasing congestion.

By increasing transit efficiency, technology can set the stage for the automation. For example, Computer-Aided Dispatch / Automatic Vehicle Location (CAD/AVL) systems can reduce the amount of time on-street transit spends in traffic. Advanced Driver Assistance Systems can increase safety for all street users and can reduce costly collisions that take vehicles out of service. Off-board fare collection and other emerging fare payment and transfer technologies can speed operations and make trips easier for customers. Vehicle-to-infrastructure communications can reduce emissions and address service bunching. Real-time data can help riders make trips that work for them, and can help operators match service to changing travel patterns. These tools can make transit stronger and support successful roll-out of AV technology and Mobility as a Service frameworks.

To prepare for AVs, cities should...

-  **Enshrine a Commitment to Transit in Asphalt and Concrete**

To prepare for AVs, cities and transit agencies should take bold strides to designate street space for transit. Such efforts will help transit take advantage of automation sooner (it is easier to automate a vehicle that runs on a fixed, routine route), and also rebuild ridership and a political constituencies for transit. Cities and transit agencies can begin by upgrading busy bus routes into rapid, high-frequency lines, adding transit-signal priority technology, and by investing in station infrastructure that anchors bus transit in place and supports better operations.
-  **Ensure Fleet Vehicles and Station Infrastructure is Wired for Technology**

On-board and in-street information infrastructure is essential to support AV transit, better manage service, and communicate with riders. Cities should ensure they have the hardware and software necessary to support transit signal priority and vehicle-to-vehicle/infrastructure communications. Open-source data feeds can help cities and transit agencies collaborate with third-party developers and provide riders with useful trip planning tools and service updates.
-  **Redesign Bus Networks for Improved Travel Time and Reliability**

Riders flock to transit when transit services are fast, reliable, convenient, and efficient. To best take advantage of the potential increases in efficiency offered by AV technology, cities and transit operators should collaborate on holistic transit network redesigns that will improve service and simplify transit operations. In particular, transit operators should prioritize frequency and convenient transfers rather than focus on offering one-seat coverage. Commute trips represent less than 1/3 of all trips; transit agencies should explore options to expand service at off-peak hours. AV technology can help agencies to expand hours and areas of operation, closing gaps in existing transit service while attracting more riders.
-  **Streamline Payment and Transfers**

Complicated or proprietary payment systems and inefficient or costly transfers discourage people from choosing transit. Existing and emerging technologies can make fare payment clear and easy, and increase ridership now. Operators should eliminate transfer fees, offer discounts for multi-modal travel, and enable payment through a single portal for all services, whether public or private. In upgrading payment systems, cities and transit agencies should ensure economic equity. For example, transit agencies could cap fares once customers have paid the equivalent of a monthly pass.
-  **Start Transitioning Transit Fleets, Support Infrastructure, and Staff**

Many safety, efficiency, and sustainability goals are already within reach with emerging technology. Cities and transit agencies can adopt Direct-Vision standards, set fleet fuel economy standards and target dates for fleet replacement, and tie targets to VMT reduction goals. Cities can prioritize electric vehicle infrastructure for buses and other high-capacity vehicles that reduce VMT. Finally, cities and transit operators can invest in staff development to ensure that workers have the technical skills to oversee and maintain autonomous fleets, and to engage in a wide variety of customer support and security functions.

Transit Moves More People, Faster

● = 1,000 people

Private Motor Vehicles:

1,600 people per hour (max)



Mixed Traffic with Frequent Buses:

2,800 people per hour (max)

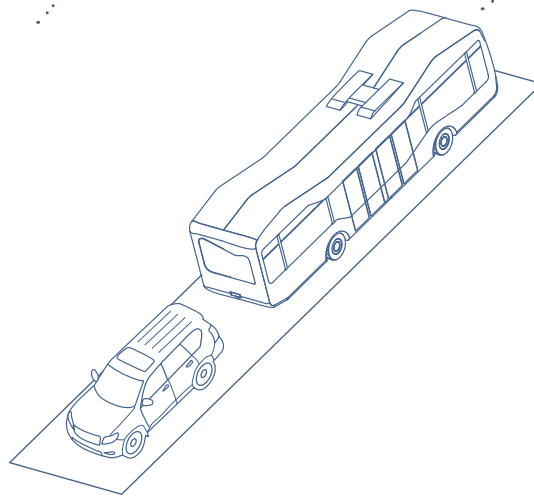
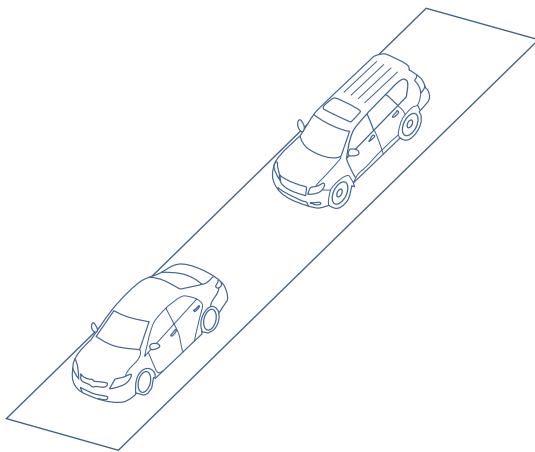

Section 2:

Policies to Shape the Autonomous Age

Dedicated Transit Lanes:

8,000 people per hour (max)

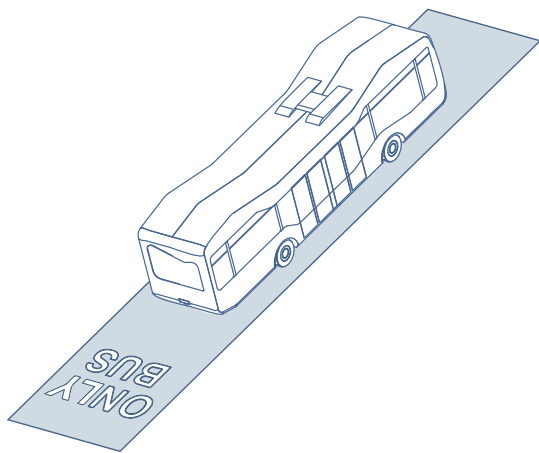

On-Street Transitways, Bus or Rail:

25,000 people per hour (max)

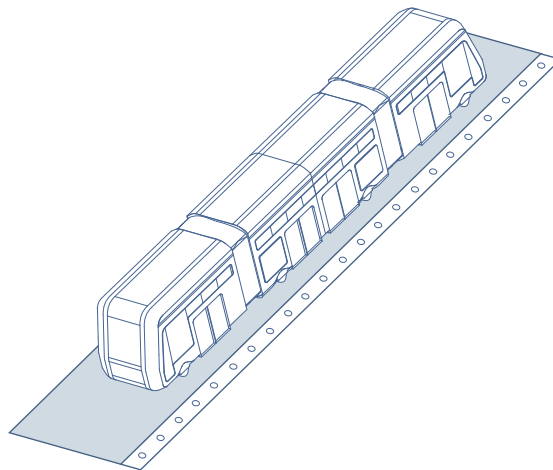

The Bus of Tomorrow

Technology offers huge opportunities to re-invent the bus, the workhorse of transit in North America. Even before autonomous transit vehicles appear on the market, cities and transit agencies can realize many of the promised safety, efficiency, and customer experience benefits by upgrading buses and station infrastructure. These decisions can help to bridge the gap between current service and fully integrated Mobility As A Service frameworks.

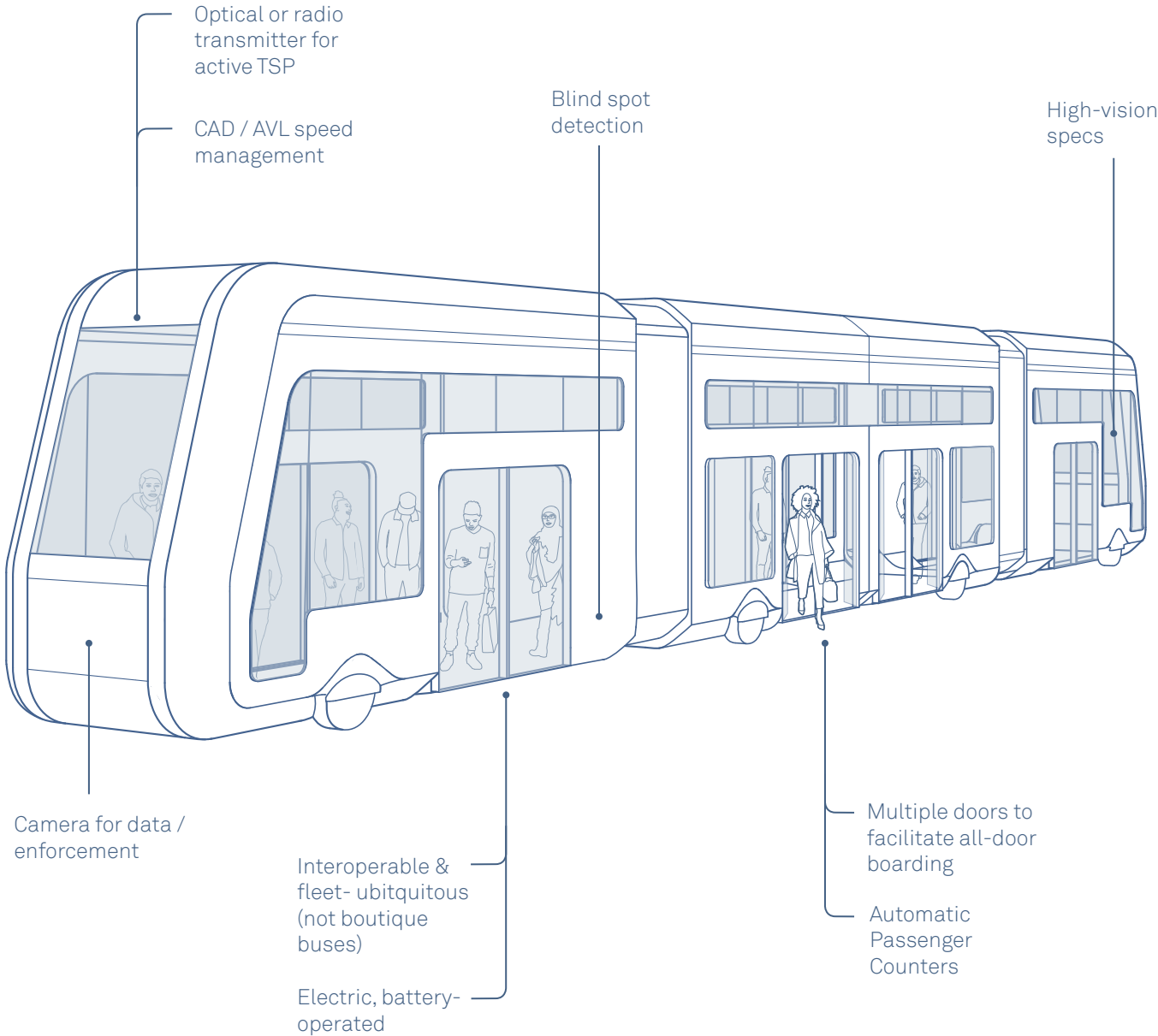

The Bus Stop of Tomorrow

New technologies can also reinvigorate public space, transforming bus stops into civic places. Real-time information can help riders make decisions about their travel choices. Embedded kiosks, vendors, and public services can enrich stations, providing riders and passersby opportunities to rest, shop, relax, and engage.

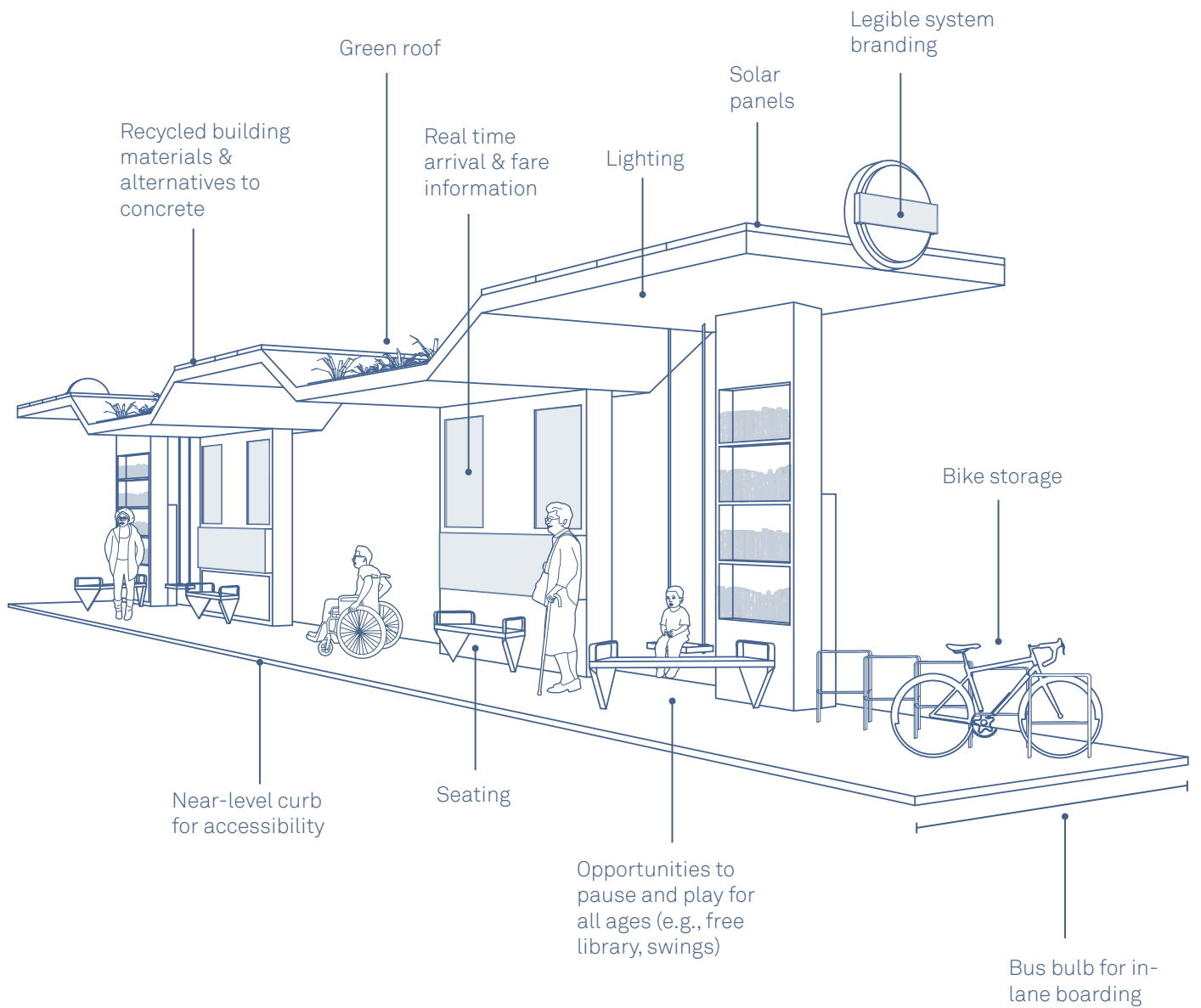

Transit, Labor, and Automation

The labor impacts of advances in automation will be complex and far-reaching, particularly for workers employed in the commercial driving sector. This includes 300,000 transit operations and maintenance workers²⁹, the majority of whom are members of public-sector unions. In particular for transit, the nature of the jobs may change considerably, shifting away from driving functions and toward more complex, varied jobs in communications, planning, customer service, maintenance, and security. To avoid major labor and political disruptions, cities must engage with their transit labor force early and often to examine where and how AV development will impact jobs and prepare for the workforce needs of tomorrow.

In an ideal autonomous future, technology will enhance transit's competitiveness, adding more riders and creating new jobs through strong service growth. Transit agencies can ensure this future by using their preparation for AVs as an opportunity to reshape and retrain their labor force in ways that can dramatically improve service. Savings from increased efficiency should be re-invested in workforce development to ensure that both current and future employees have the training and skills they need to thrive in a dynamic, uncharted autonomous future.

To prepare for the complexity and sophistication of jobs in an autonomous age, transit agencies, cities, labor unions, and workers should begin collaborations now to develop plans, policies, and procedures that make hiring simpler and increase diversity in recruitment. In addition, to ensure that existing and future workers can continue to adapt to innovations, agencies should expand opportunities for on-going career and professional development training, and create new vertical career pathways and opportunities for promotion.

As they prepare for the uncertainties ahead, transit agencies and cities should look to future-proof their workforces by rethinking and overhauling tools, like civil service exams, that guide hiring and promotion decisions. For example, in developing job descriptions, cities and agencies may want to prioritize agility and ability to learn, rather than requiring specific skills (such as having a driver's license or minimum years of experience or education) that may be inappropriate or obsolete in an autonomous age.

Micro-Transit, Micro-Niches

In urban areas, fixed route transit in designated rights-of-way is the most efficient way to move people in large numbers. The struggles of "micro-transit" services (e.g., Chariot, Bridj) show how difficult it is to aggregate more than a few riders into a single vehicle on a non-fixed route, even with app-based dispatching. Nationally, it costs more than six times as much money per passenger to run a demand response service than it costs to run fixed route bus services.³⁰ In the New York Metro Area, demand response services cost fifteen times more per trip than bus service.³¹

The bus's advantage comes from having riders come to it, rather than the other way around. Without the aggregation efficiencies of fixed-route transit or the point-to-point convenience of bicycling or cars, the niche for micro-transit is similar to that of carpooling or taxi-pooling: collecting riders from a few dispersed places and bringing them to transit stations or low-transit employment hubs. Some transit agencies have explored using micro-transit to replace low-frequency 'coverage' service or paratransit with on-demand service. However, to date, ridership in micro-transit pilots that replaced fixed-route bus service has typically been lower than the low-ridership 'coverage' bus routes that were replaced.^{32,33}

Informal transit in middle-income cities worldwide offers a lesson for microtransit and pooled travel services. Even with extremely low labor costs, these services show that high-volume, on-demand service is inherently slow, and gets outperformed by organized fixed-route service when it exists on a similar route.³⁴



Technology in Transit Today: Vancouver's SkyTrain

As North America's largest automated train system, Vancouver's SkyTrain illustrates the potential for integrating automation into transit networks. Operated by TransLink, SkyTrain is a driverless system providing rapid transit service to the entire Metro Vancouver region. SkyTrain serves more than 468,000 average weekday boardings, maintaining reliable two to three-minute headways throughout the day and eight- to ten-minute headways into the late-night.^{35,36} Operating three lines on grade-separated guideways, a digital railway signaling technology called SelTrac controls the vehicles' movements.

Shorter trains and platforms can be optimized for use in automated systems like SkyTrain. In addition to lower upfront costs, automated rail systems can run smaller trains at frequencies significantly

higher than is possible for traditional systems. For instance, TransLink provides service every two to three minutes during peak times with a maximum capacity of 25,700 passengers per hour in each direction.³⁷ This efficiency has helped to bolster market development for the full transit system, where network-wide ridership grew 6 percent (and local bus ridership grew more than 3 percent) from 2016 to 2017.³⁸

SkyTrain's high frequencies are due in part to the system's ability to operate without a driver. However, automated systems still have a need for employees across the system, such as for maintenance and customer service, safety, and security.³⁹ SkyTrain attendants staff most stations for these functions and cost savings from automated transit go towards improving customer service and keeping the system in a state of good repair. These customer-facing roles have the potential to enhance transit's competitiveness and performance.

Network Planning for the Autonomous Bus

AVs offer unique opportunities to address declining transit ridership in many North American cities by increasing bus service. To maximize these benefits, cities and transit agencies must match the increases in service hours and transit frequency provided by AV technologies with strategic network redesigns that help transit best serve the trips that people want to make.

Bus network redesign is essential to the successful adoption of AV technology in transit. Today, many metro areas in the US are served by bus networks that radiate out from a central core. In these systems, a person traveling between two points outside of the city's downtown core may need to take the bus all the way into downtown, then transfer to another bus to make the trip back out to their destination. Radial networks typically facilitate one-seat, rush hour trips to the central business district but are inconvenient for the majority of types of trips that people make, for example non-commute trips, trips between neighborhoods, weekend or evening trips, or trips in polycentric regions. Even with increases in service that could come from AV-based transit, most radial transit networks would still fail to provide the kind of service that people need or want to shift from single-occupancy cars.

In contrast, grid-based network redesign can help transit agencies capitalize on the increased frequency and expanded service provided by autonomous buses by making individual trips time-competitive with single-occupancy vehicles and ride-hail. Grid-based networks are most efficient when supported by bus-only or bus-priority lanes. Even before AV buses are fully deployed, grid-based network redesign can help win back ridership. An analysis by Houston Metro of how a grid-based network would impact Houston found that, using the same number of service hours, they could reduce travel times by more than 20 minutes for 28% of trips, and reduce travel times by 5 to 20 minutes in an additional 49%.⁴⁰

Tools for Better Transit: Signal Priority in Minneapolis

Minneapolis' METRO C Line bus rapid transit project began revenue service in June 2019, providing faster, more frequent service from Brooklyn Center to downtown Minneapolis. Transit Signal Priority (TSP) was enabled at 15 traffic signals along the route in Minneapolis. With this technology, a late running bus communicates with the traffic signal cabinet via a radio antenna, then the traffic controller either extends the green time or provides an early return if it arrives on red. TSP provides more reliable travel time with less delay at the traffic signals. The C Line project is the 4th bus route to install TSP in Minneapolis. There are now 70 traffic signals in the city with TSP and several more bus routes are planned to be upgraded in the next 5 years.

Network Today

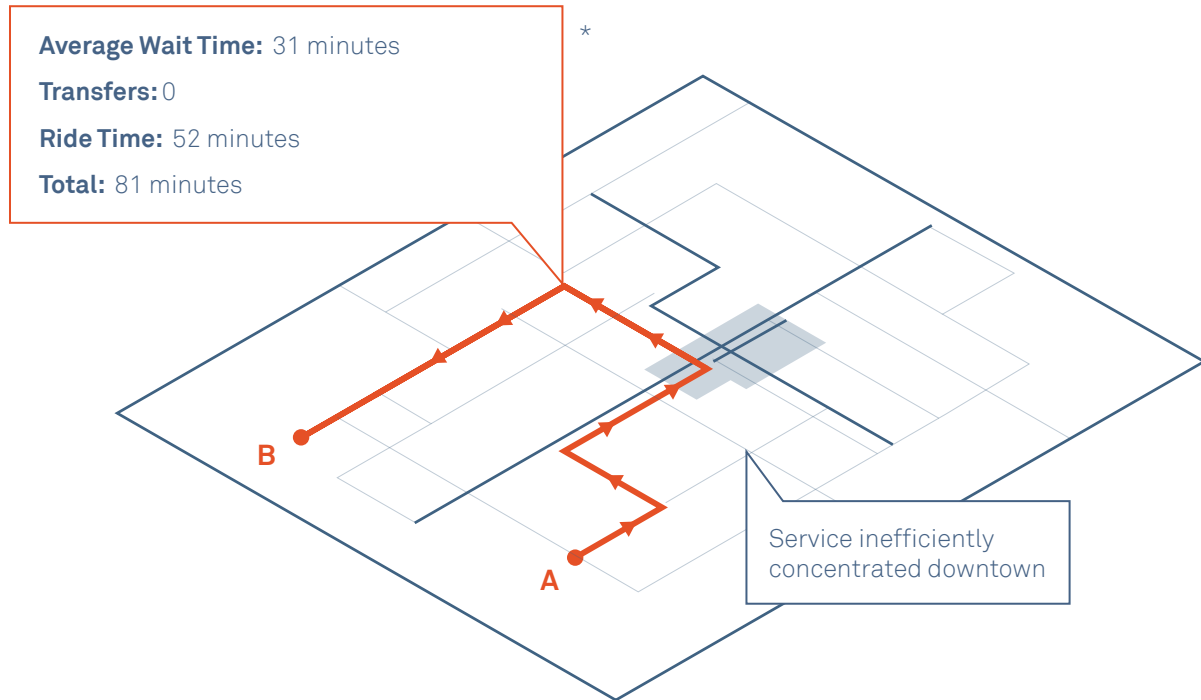

Future Network

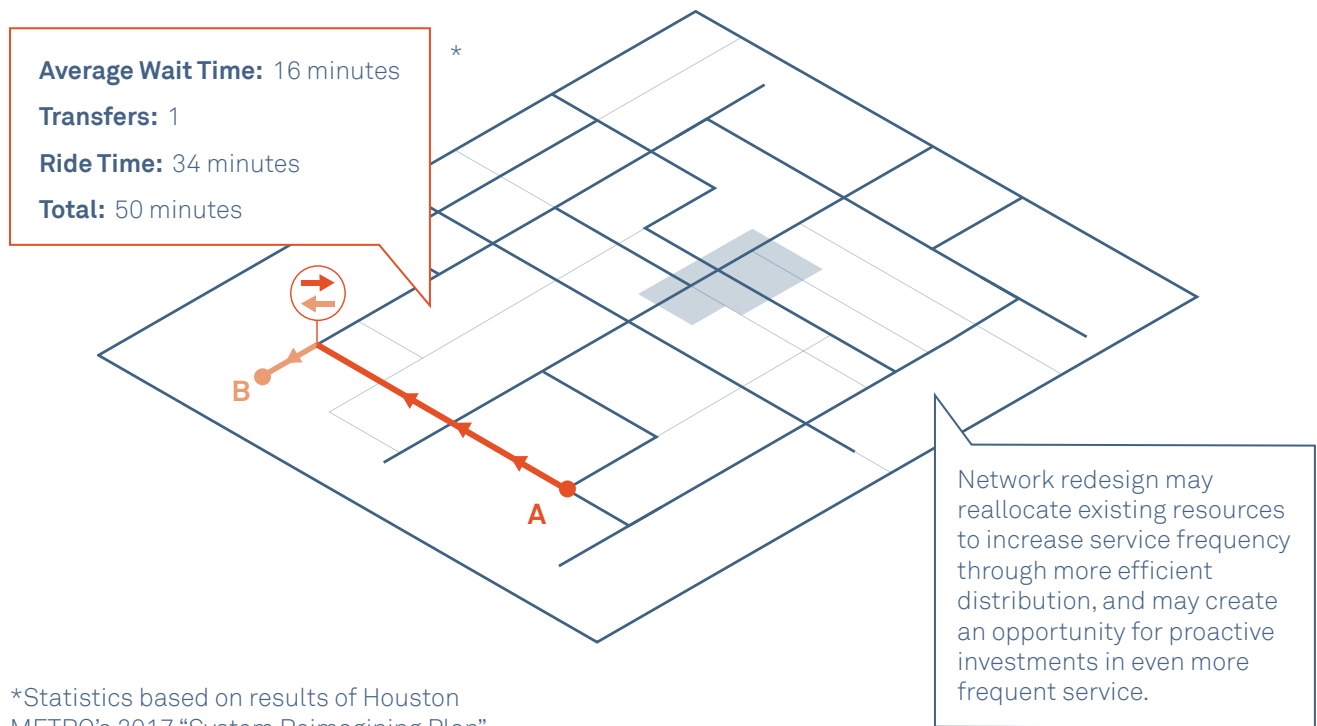

*Statistics based on results of Houston METRO's 2017 "System Reimagining Plan"



Photo: Alain Rouiller, Flickr (London)



2.2

Pricing

Types of Congestion Pricing	60
How Much to Charge.....	63
Pricing for Equity.....	64
From Ride-Hail to AVs.....	64
Congestion Pricing Case Studies.....	66

2.2

Pricing

Across the globe, traffic is getting worse. In the United States alone, vehicle miles traveled (VMT) hit an all-time high of 3.2 trillion miles in 2017.⁴¹ US drivers spent an average of 97 hours sitting in traffic that year and the total cost of congestion, including productivity, fuel waste, and other factors, was over \$300 billion.⁴² Accelerating automobile use across the globe has dismal implications for climate change: in the US, transportation is responsible for the largest share of all greenhouse emissions, the most of any sector, with almost all of it coming from cars and trucks.⁴³

Absent policy mechanisms and incentives to encourage people to drive less, traffic will continue to increase.

Absent policy mechanisms and incentives to encourage people to drive less, traffic will continue to increase. A well-documented behavioral phenomenon, called “induced demand,” shows that as governments build more or wider roads, people drive more and congestion gradually increases. While this impacts all travelers in terms of longer journey times, often the poorest residents are hit the hardest. With affordable housing options located farther from city centers and increasing numbers of people forced to commute long distances by car, low-income populations are most likely to be burdened by the time costs of increased congestion.

In an autonomous future, pricing is a core policy lever. New technologies could allow governments to gauge traffic in real time and accurately price travel demand to influence traveler behavior. Pricing would allow cities and regions to develop reliable funding sources for transit, providing more and better transit

service to make it easier for people at all income levels to move around. By reducing the number of single-occupancy vehicles entering intensively used areas, pricing gives cities an opportunity to repurpose the public space. Such space could be used for sustainable transportation options like transit, bikes, walking, for small businesses and vendors, trees, and open space.

Pricing may also be needed to address the externalities of automation itself. Many transportation experts believe that AVs will lower the cost of travel and induce even more demand.⁴⁴ Without adequate government intervention, it is unlikely that the autonomous world will be shared. In such a scenario, the low cost of an individual automated ride could draw commuters off the transit network, encourage people to live further from cities, and add millions of vehicle miles traveled. Early studies are already showing that ride-hail services are increasing VMT.⁴⁵ The end result would be even more gridlock, imposing new costs on people, cities, and the environment. Pricing will be essential to avoid this dystopia.

Until recently in the U.S., elected officials have been reluctant to embrace meaningful congestion pricing. However, perhaps due to the rise of ride-hail services, the way that people think about transportation payment and pricing is evolving. Consumers are quickly becoming accustomed with “surge,” variable, and peak pricing. Electronic tolling systems and payment platforms have made it more convenient to pay for travel. In March 2019, the New York State legislature passed cordon pricing authorization for New York City, and other cities may follow suit. Learning from cities such as Stockholm and London, which charge a fee to enter the city center, North American policymakers are exploring the potential of similar charges to cut traffic in the most congested areas of cities, and increase the efficiency of our transportation networks as a whole.

To realize the full value of the public right-of-way in the AV age, cities should:

Start Developing Pricing Plans & Policies to Reduce Congestion

Cities should take lessons from their peer cities around the world who have successfully implemented pricing policies. Cities and transit agencies should begin by empowering an independent body of diverse, local stakeholders to propose and evaluate pricing scenarios and funding streams to expand transit. The resulting public engagement can serve as a strong foundation for implementation.

Ensure Pricing Revenue is Dedicated to Improving Transit, Walking, and Biking

The full benefits of congestion pricing can only be realized when transit service is a viable and attractive alternative to driving. While cities can already take steps to improve transit's frequency and reliability, a commitment to using future revenue to expand transit options is essential to encourage and sustain mode shifts. Cities should also dedicate revenue towards investments in active transportation to support walking and biking.

Prioritize Equity When Pricing Mobility

Pricing policies make hidden costs (e.g., congestion, loss of productivity, traffic fatalities, air pollution, carbon emissions) explicit. As cost burdens shift and change, policy makers must ensure that low-income people are not inequitably impacted. Using revenues from pricing to support transit improvement is the best way to ensure equitable outcomes for everyone. In the research and public input process, cities can explore options to expand access to transit to help reverse the economic impacts of structural racism in transportation planning.

Develop a Coalition of Support

Support for congestion pricing must come from a broad coalition of local stakeholders, including the business community, grassroots activists, civic leaders, and elected officials. Building a broad base of support means undertaking a long-term, active strategy for community engagement and identifying coalition partners to assist in the development and promotion of a large-scale pricing policy.

Use a Data-Driven Approach to Implement and Evaluate Any Pricing Scenario

Accurate, comprehensive data about activity on city streets is critical to shaping and monitoring the impact of a mobility pricing program. Cities need robust data management policies and in-house expertise to determine where the highest levels of transportation demand exist and how different pricing tools can improve safety, congestion, and sustainability outcomes. Detailed data about regional and citywide travel behavior will inform successful implementation of pricing policies and their future impact.

Types of Congestion Pricing

Pricing can be divided into three categories, each focusing on a different aspect of the trip as the place to insert the financial incentive.

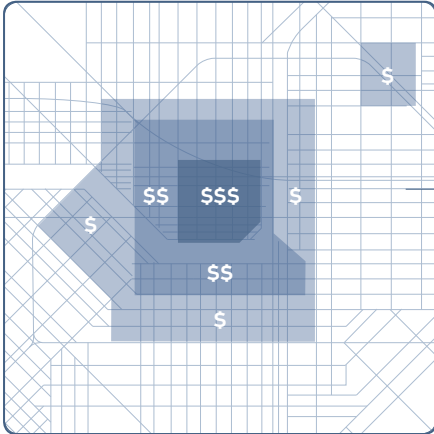

Price the Place

Cordon Pricing

Cordon or zone-based congestion pricing reduces congestion by charging a fee to enter a specific zone or zones of a city. Cities can establish zones based on land use or existing levels of congestion. Cordon pricing can be a flat fee or variable, changing over the course of the day to target congestion at peak periods. Cordons can also focus on specific vehicle types (e.g., high-polluting vehicles or large trucks). For example, in 2019, London instituted an Ultra Low Emission Zone (ULEZ) to reduce the number of high-polluting vehicles coming into central London and improve air quality. Cordon pricing produces the most significant results for congestion mitigation and greenhouse gas emissions reductions compared to other forms of road pricing. Using cordon pricing revenues to fund improved transit is key to congestion mitigation impacts.

e.g., London

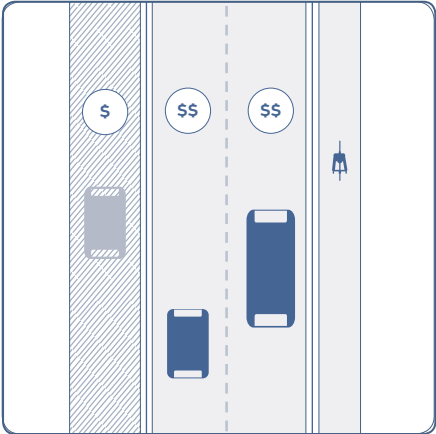

Price the Curb

Performance-Based Parking / Loading

In dynamic parking or loading zones, cities charge a fee based on use and/or time the curb space is occupied. A loading fee may be assessed for freight and passenger pick-up/drop-off. These fees require a detailed curb asset inventory, which many cities do not currently have. Increased precision in on-board GPS and newer, cheaper sensor technologies may increase opportunities for curb pricing in the future.

e.g., Washington, DC

Section 2:

Policies to Shape the Autonomous Age

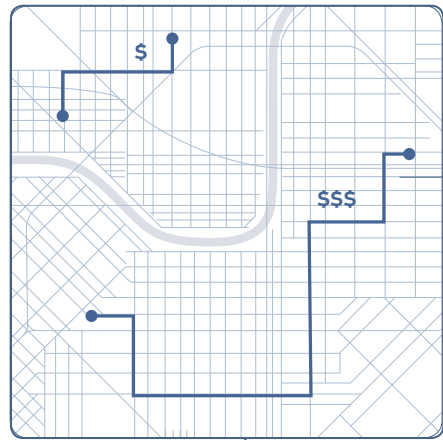

Price the Trip

Per-ride Taxes and User Fees

User fees are designed to discourage types of single-occupancy vehicle trips at certain times and places. User fees are most often applied to ride-hail trips. How fees are assessed varies based on city and state legislation; some mechanisms create a stronger incentive to reduce driving. For example, ride-hail fees that are calculated as a percentage of the total fare may produce limited decongestion benefits because the financial (dis)incentive is tied to the passenger's travel, rather than to the vehicle's travel. That is, when there is no passenger—and therefore no revenue—there is no financial disincentive to drive.

e.g., Chicago

HOT / Managed Lanes

High-Occupancy/Toll (HOT) Lanes are designed to reduce congestion by incentivizing ride sharing. When well-placed, tolls can discourage local travel on major roadways or encourage drivers to consolidate or limit their trips. However, poorly placed tolls can actually make congestion worse. For example, in New York City, tolls on cross-city highways incentivize interstate traffic to shift to untolled local roads and bridges, increasing congestion in the city core.

e.g., Virginia

Vehicle Miles Traveled (VMT)

VMT fees are assessed based on the number of vehicle miles traveled. By directly pricing travel, VMT fees ensures stable revenue in light of changing vehicle fuel economies and ownership models. Over time, VMT fees could replace gas taxes and help fund infrastructure on a large scale.

e.g., Oregon

A Short History of Cordon Pricing

Private toll roads have existed in the United States since the colonial period. In the 1960s, William Vickrey suggested that the governments that build the roads should also charge ‘customers’ for their use. Vickrey’s idea has gained popularity as the congestion and emissions impacts caused by unrestricted “free” driving have become evident. More recently, governments have begun to employ dynamic pricing to maintain free-flow traffic conditions along certain routes—such as I-15 in San Diego (in the high-occupancy vehicle lanes) or Route 66 in the Washington, D.C. metro area. These projects employ fluctuating tolls that change in \$0.25 increments every few minutes depending on traffic levels.

Besides charging for travel on select roads, a number of cities, including Singapore, London, Stockholm, and Milan, have implemented a cordon charge to reduce traffic congestion and emissions in the city core. In 1975, Singapore implemented a flat charge of \$1.30 per vehicle entering the city’s central business district between 7:30 and 9:30 am, eventually switching

to a variable fee depending on the time of day and direction of travel. London followed suit in 2003, charging motorists £5.00 to enter central London (the charge has since increased to £11.50). Stockholm, which introduced its cordon in 2006, charges a varying rate to enter the city that tops out at \$4.40 during rush hour. In all cities, revenue raised from these cordon charges is used to fund transit service and other modes, which is essential to the success of the charge.⁴⁶

In all the cities where it has been implemented, cordon initiatives have led to less congestion, reduced emissions, faster travel times, and improved pedestrian safety. In London, for instance, the charge reduced the number of automobiles entering the city by 30 percent.⁴⁷ Public approval is also strong. In Stockholm, for example, approval for the cordon charge started around 40 percent in the years prior to implementation, fell to around 30 percent right before the cordon was enacted, and then climbed quickly to around 70 percent as citizens saw the clear benefits of fewer cars in their city core.⁴⁸

Stockholm Congestion Pricing Approval Rating

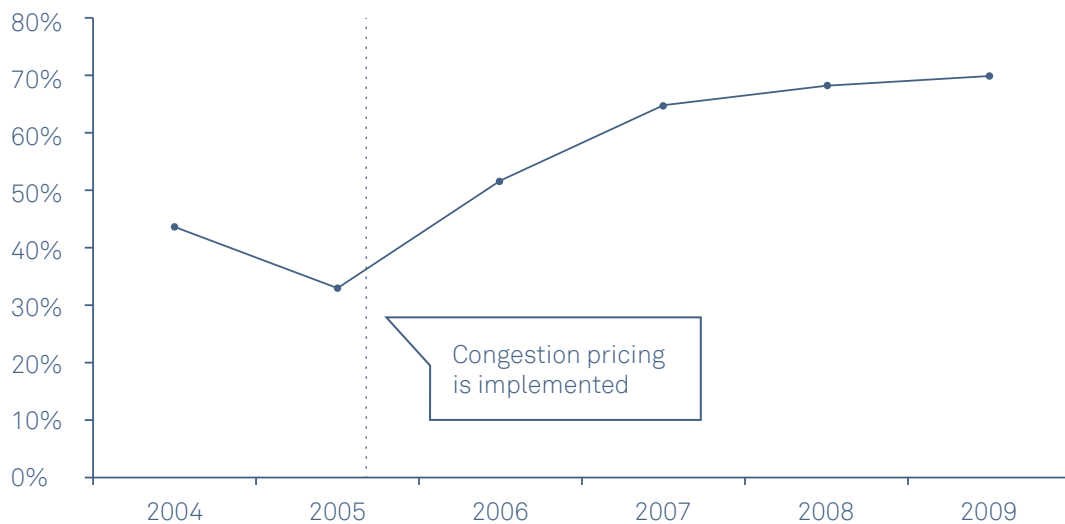

How Much to Charge

Key to achieving traffic and emissions reductions is identifying the appropriate price point for congestion charges, defining the purpose of the fee, and aligning the parameters of who is charged with the policy outcomes desired. For some types of pricing, like ride-hail user fees, the cost is passed on to riders who are already more likely to be affluent. As a result, higher charges may be necessary to reduce single-occupancy vehicle trips. Studies show that a flat \$3 ride-hail fee, like the one recently adopted by New York City, would only reduce ride-hail trip volumes and mileage by 3 to 4 percent.⁴⁹ The same study by Schaller Consulting suggests that the average trip charge on ride-hail vehicles must be \$10 or more to lead to a meaningful reduction in ride-hail vehicle miles traveled⁵⁰. In many cities, the singular focus on ride-hail vehicles, combined with the low initial trip price, may mean that user fees do not adequately reduce congestion.

When cities with strong transit networks adopt cordon charges, the cordon price can often stay relatively low because people have an equally good alternative to driving; a minimal price nudge is enough to discourage single-occupancy vehicle use. For example, in Stockholm, the initial cordon fee was set at around \$1 which produced an immediate 20 percent reduction of vehicle traffic into the city core.⁵¹ Stockholm's success at a low cordon price point comes from its already strong transit network which it augmented with almost

200 new buses, 16 new routes, and new bike lanes. More recently, Stockholm has shifted its cordon to variable pricing based on time of day with a maximum charge of 35 krona (US \$4.14). Experts note that in all successful cordon pricing examples, revenue from pricing is reinvested into buses and other surface transit which creates more and better alternatives to single-occupancy car use.

Determining the appropriate fee is tied to the behavior that the charge is meant to address and what alternatives people have. In places where there are fewer alternatives to driving, peoples' willingness to pay goes up. In 2018, a dynamic toll was enacted along I-66 leading into Washington, DC. The toll peaked later in the year at \$46 due to high demand.⁵² Similarly, London's new cordon, the Ultra Low Emission Zone (ULEZ), adds a £12.50 charge, in addition to the existing cordon charge, to high-polluting vehicles entering central London. This large charge suggests that a heavier price incentive may be needed to discourage high-polluting vehicle use, especially in the absence of options, especially for freight movement. To create more alternatives to high-polluting trucks, Transport for London and the Team London Bridge business improvement district have partnered to incentivize e-cargo trikes for freight and courier service in central London.⁵³



Photo: Citytransportimo, Flickr

Pricing for Equity

Ensuring that policies reduce, not exacerbate inequities, is essential to the success of any pricing policy. Pricing plans, in particular, often trigger conversations about equity because they force people to confront hidden racial and economic inequities caused by driving (e.g., longer commute times, increased traffic fatalities and reduced air quality in poorer neighborhoods and communities of color, less leisure time, increased carbon emissions, etc.). While research shows that the majority of people who would pay cordon charges have higher incomes⁵⁴, the systematic underfunding of reliable, convenient alternatives to single-occupancy driving, means that conversations about the immediate impacts of pricing are often fraught.

To ensure that cordon pricing schemes reduce economic inequities, policy makers often provide selective discount programs or exemptions. In London for instance, disabled drivers entering the cordoned zone pay only 10 percent of the total fee.⁵⁵ Existing transit pricing systems provide a model other cities can adopt to ease cost burdens on low-income individuals. London's Oyster and contactless systems, for example, track monthly fare payments and stop charging a customer once they have paid the equivalent of a monthly pass.⁵⁶ This assists lower-income customers who cannot afford the pass' up-front cost, and makes it more appealing financially to choose these modes.

Dedicating revenue from congestion pricing to expanding and improving transportation alternatives such as transit, walking, and biking is essential for addressing the equity impacts of pricing. Cities and agencies considering cordon pricing should center equity in their plans by using revenues to expand and improve transit frequency and reliability, exploring options to reduce transit prices and expand income-based discount programs, and augmenting employee training programs and benefits.

From Ride-Hail to AVs

Ride-hail companies are often viewed as a stepping stone to the automated mobility future.

As a result, cities can explore pricing strategies now with ride-hail vehicle, gathering experience on how best to price AVs in the future. For example, the surge pricing model, brought into the general consciousness by ride-hail companies, could be a model for how cities might begin to calculate congestion pricing in the future. When the number of ride requests rises beyond the number of drivers on the road, companies begin to raise prices to both entice drivers to 'clock in' and convince at least some passengers to hold off on their travel. Surge pricing is updated based on demand in real time, meaning it can change within even just a few minutes, and is based on each individual driver and rider feeding information into a central platform rather than relying on on-street infrastructure to conduct vehicle counts—dramatically lowering the cost of monitoring the network.

Similarly, governments could charge an empty vehicle or multi-level fee: one rate for the period when the vehicle has a customer, and a second for when it is unoccupied. Such a structure would encourage trips while discouraging unnecessary idling and cruising. Already, data suggests that ride-hail vehicles operate without a passenger 30-60 percent of the time⁵⁷, underscoring the need for a pricing tool to correct the market. Many experts worry that this pattern could continue in an automated future, with privately-owned AVs driving their owners to work, dropping them off, then returning home for the day. Pricing would be an effective mechanism to discourage this behavior.

Automation has the potential to significantly alter the current ride-hail business model. Since companies are more likely to own their fleet, they have the means to collect higher profits compared to today's model where individual drivers receive some of the revenue from rides. Companies may also devise algorithms to minimize empty travel time. Based on the cost of driving without a rider, ride-hail companies may employ 'rematch' where a vehicle is assigned a new ride just as they finish their last one. Governments should monitor occupancy status of AVs and incentivize companies to minimize empty travel time, as opposed to remaining empty until finding the most profitable trip.

First steps toward pricing in North America

Vancouver, BC

In 2017, the TransLink Board of Directors and Mayor's Council on Regional Transportation empowered the Independent Mobility Pricing Commission to study options and potential impacts of congestion pricing in Metro Vancouver. The Commission consisted of 15 local leaders with backgrounds in transportation, business, and community organizing and advocacy. The Commission presented its final report in May 2018, demonstrating mobility pricing as a long-term, sustainable tool to address the region's transportation challenges.

Los Angeles

In early 2019, LA Metro's board of directors unanimously voted to approve the region's first-ever comprehensive analysis of various forms of congestion pricing in early 2019. The study covered pricing options from per-mile taxes, entry fees to certain neighborhoods, and per-ride fees on for-hire vehicles. These research aspects of Metro's road pricing initiative, named "The Re-Imagining of LA County" will take 12 to 24 months and include a strategy for addressing equity.

Seattle

In 2018, as part of Mayor Durkan's commitment to climate action, the Seattle Department of Transportation began a feasibility study on pricing. Working with the consulting firm Nelson\Nygaard, the city released a report in 2019 that analyzed congestion pricing strategies for Seattle with a special focus on equity. The study provides a starting point for discussions about what a pricing program might look like for Seattle and will inform a series of conversations and additional research around congestion pricing.⁵⁸

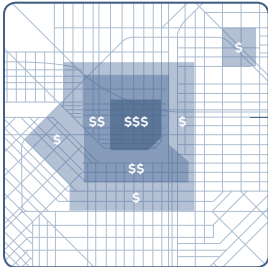

Photo: Doug Gordon / @BrooklynSpoke

New York

After more than a decade of effort from city government and advocacy groups, NYC is on the cusp of becoming the first US city to implement congestion pricing. In 2015, the advocacy group Move NY published a plan to reduce emissions from traffic congestion. In 2017, a fee on for-hire vehicles was put into effect. In March 2019, the State Legislature approved congestion pricing with the stipulation that revenue from the program would fund transit improvements in the city. Congestion pricing is slated to begin in early 2021.

Congestion Pricing Case Studies



London, 2003

Drivers entering London's 8 square mile congestion zone must pay £11.50 between 7 am and 6 pm on weekdays. Across the cordoned zone, 1,360 cameras placed at 348 sites read the license plate numbers of automobiles entering and driving within it. Taxis, disabled drivers, and certain low-emission vehicles are exempt from the charge while zone residents pay 10 percent of the standard fee. The £2.5 billion in revenue raised by the charge was reinvested in public and active transportation.

London's charging scheme cut congestion delays by 30 percent while increasing average travel speeds by 30 percent. The number of bus, rail, and bike trips all increased after the city introduced its pricing system with bus ridership reaching a 50-year high in 2011 and bike trips increasing 79 percent between 2001 and 2011.⁶⁰

In 2019, the city launched the Ultra Low Emission Zone (ULEZ) in central London, covering the same area as the cordon pricing zone. Vehicles driving in the ULEZ must meet stricter emissions standards or pay a daily fee to drive in the area. The ULEZ is in effect all day, every day throughout the entire year.



Washington, DC, 2017

The Multimodal Variable Pricing Pilot (MVPP) in Washington, DC's Penn Quarter/Chinatown uses sensors and analytics to provide real-time parking availability information and price parking according to demand for nearly 1,000 spaces. Meters for these spaces are adjusted to one of eight price points between \$1 to \$5.50 per hour, depending on the time of day. Varying time limits, real-time traveler information, and adjustable parking fines are used as additional levers to influence demand. Initial results indicate that the program improved vehicle turnover and parking utilization, improved placard compliance, reduced the incidence of double parking, increased meter revenues, resulted in mode shift, and received positive feedback from local business owners, customers, and delivery drivers.⁵⁹ The pilot program became permanent in 2019.

Section 2:

Policies to Shape the Autonomous Age

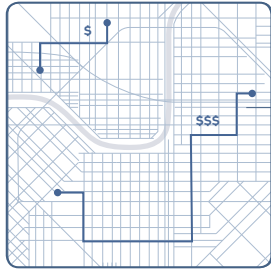

Chicago, 2015

Chicago's city council passed a 52-cent per-ride surcharge on all ride-sharing trips in 2015, raised to 67 cents in 2018. While revenue from the initial fee went into the city's general budget and accessible vehicle fleets, proceeds generated from the 2018 increase are being invested in the Chicago Transit Authority (CTA). The fee will increase in 2019 to a total of 72 cents per ride.

In 2017, the city raised \$86.9 million from the fee, and is projected to raise an additional \$37 million for CTA by 2019. These revenues are funding a \$146 million capital improvement program to improve reliability and speeds over the next five years on the Red, Blue, Brown, Green and Pink Lines and a \$33 million program to enhance system safety through the expansion and upgrading of system-wide security cameras and station security features.

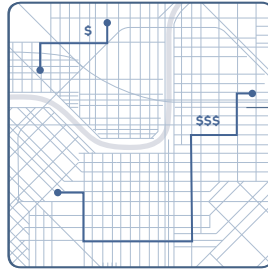

Oregon State, 2001

OreGO is a VMT-based pricing program that began in 2001 and is currently in a permanent pilot phase. Voluntary participants pay 1.5 cents per mile-driven in place of the state gas tax. The program is designed so that any vehicle with higher than 20 mpg fuel economy would pay less than the current gas tax.

Those who opt in to the program receive a device to measure VMT and are reimbursed for state gas taxes paid at the pump. Amidst other state-level proposals to fund transportation projects, Oregon DOT stands ready to make the VMT program available to more users.

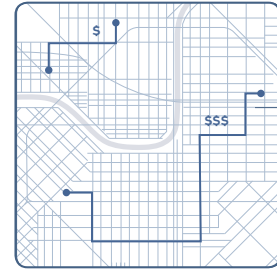

Virginia, 2017

In 2017, VDOT levied dynamic tolls on a 10-mile section of I-66, a highway running between Washington, DC and its suburbs. Previously restricted to high occupancy vehicles during peak hours, solo drivers can now use I-66's new express lanes by paying a toll. The tolls recalculate every six minutes using a pricing algorithm that responds to demand and keeps traffic flowing at a minimum of 45 mph. The tolls are in place in the peak travel direction between 5:30 to 9:30 am and 3 to 7 pm. Monday through Friday.



Photo: Seattle DOT (Seattle)



2.3

Data

Defining Transportation Data.....	70
Asset Data: The Worldwide Street.....	72
The Path of Journey Data.....	74
The Challenge of Journey Data and Privacy.....	76
Data Anonymization Methods.....	77

2.3

Data

Data has always played a key role in transportation planning and management. But today, the sheer amount of data collected has transformed data from a planning tool into an integral piece of infrastructure. Current estimates suggest that AVs could produce upwards of 4TB of data every hour as they move throughout a city.⁶¹ This unprecedented volume of data requires cities and companies alike to transform their data management practices.

Before the advent of mobile phones and GPS, transportation data collection was labor-intensive and, as a result, largely a series of “moment in time” snapshots of activity on the street. Typical journey data sets include manual traffic counts, automated traffic recorders, travel time runs, surveys, and trip diaries. Payment and turnstile data provide basic transit statistics.

The introduction of GPS to taxi fleets opened up a new world of transportation data, including average traffic speeds, origins and destinations, and total geographic coverage. Bike share systems gave cities new information about the total number of cyclists. More recently, app-based ride-hail and shared micromobility services have opened the door to an even wider dataset: real-time “bread-crumbs” information about routes, precise pick-up/drop-off locations, time, trip duration, speed, and cost. AVs, which recognize, categorize, and assess environments in real time, will offer even more opportunities and challenges for data collection.

Questions about this data—how it is collected, managed, protected, and stored, by whom, and for how long—are fundamental to managing an automated future. Collected and managed thoughtfully, the data produced by AVs could provide essential information that cities can use to create policies to support positive outcomes for mobility, health, the environment, economic growth, equity, and sustainability. In contrast, poor management or misuse of data by either the public or private sectors could lead to significant degradations of personal privacy and reduce the amount of information available for public policy making.

For most individuals, data informs mobility decisions and helps save travel time. Private companies, meanwhile, use data collected from users to estimate demand, set rates, chart routes, and plan personalized trips. As markets integrate, vertically and horizontally, companies may want to use data gathered from one source (e.g., the route a person takes) to feed other products (e.g., stores along that route).

Cities hold a dual role. As consumers of data, cities need data to monitor road conditions, streamline operations, increase efficiencies, regulate vendors, and track trends over time. But, as the frontline of government that is expected to protect the public interest, cities must strive to ensure that personal data is collected, used, and stored appropriately. To prepare for the future, cities must prepare themselves to take on a strong role in data management and policy.

Defining Transportation Data

Transportation data can be divided into two major categories:

Journey Data

Journey data describes how individuals or goods get from A to B, including granular information such as where they stopped, what mode they used, or how many deliveries they received per week. Historically, journey data was challenging to acquire and time-consuming to collect. With the proliferation of GPS and Wi-Fi-enabled smart phones, journey data is now extensive. Many aspects of journey data are often personally identifiable information. Journey data is also referred to as mobility data, geospatial data, or trip data.

Asset Data

Asset data describes the infrastructure and how it is or can be used. This includes static information like the location of curbs, traffic lights, streets, or bus stops, and regulatory information (e.g., street closures, turn restrictions, etc.) about what is permissible. Today's digital asset databases are often incomplete and are incompatible with other datasets that are maintained by other agencies or private sector companies. In the future, asset data could include real-time information about use or restrictions - e.g., Is the parking space in use? Is the street open or closed? How fast are cars traveling? Did the vehicle cross the cordon line? Adding use and regulatory information to asset datasets could guide AVs and help manage street operations without triggering the privacy concerns that come with journey data.

Cities should...

Enhance Assets, Catalogue and Push Asset Data

Cities should catalogue their asset data and update street infrastructure so that they can push out real-time information about how streets are used (e.g., road closures, route restrictions, parking occupancy, delivery zone use, etc.). Cities can strategically partner with companies to implement counters and sensors. In some cases, the data collected by AVs themselves could be used to populate and maintain asset datasets. By taking an active approach to asset data, cities can guide the autonomous future in powerful ways.

Focus on Open Data Specifications & Interoperability

Open data standards are a critical precursor to successful collaboration between the public and private sectors. As the number of data tools on the market proliferate, cities face a real risk of getting locked into proprietary tools if they do not prioritize open data. Cities should review development and procurement policies to ensure that open data is a prerequisite whenever possible, and support efforts to create open standards and specifications.

Enhance and Update Data Management Policies

The rapidly growing volume and breadth of that data means that cities must proactively ensure that their data management policies are up to date. As discussed in the NACTO/ IMLA *Managing Mobility Data* guidance, cities should ensure that journey data is classified as personally identifiable information and treated as such in policies around management, storage, dissemination, and use. Cities should ensure that their data policies and practices are routinely updated and should encourage responsible data management practice from mobility vendors operating in the public right-of-way.

Build Up In-House Data Capacity

Cities should build up internal staff capacity to analyze and manage data so they can evaluate the quality of the data they receive from private vendors and push out asset data more readily. In addition to augmenting software expertise to handle analysis, cities should develop internal staff capacity around key skill or expertise areas such as data management, statistics, auditing, and fraud detection.

Control the Means of Communication

The autonomous future will require a host of short- and long-range communication systems. Cities should prepare by developing policies to manage communications hardware in the public right-of-way, pushing back on federal preemption legislation, and supporting efforts to restore net neutrality, to ensure that everyone has the ability to participate. City-owned infrastructure like utility poles and street lights are increasingly at the center of debates about access, as 5G technologies, which are expected to be the future of communications, rely on a large number of small access points (vs. the smaller number of large cell towers that support existing networks). Control over siting for this equipment will shape the landscape of communications and the autonomous future.

Coordinate for Privacy

Unlike Europe, the U.S. lacks comprehensive consumer privacy protection policies that guide how data is collected, stored, used, and shared. Already, ride-hail and shared micromobility companies have exploited this policy vacuum to lobby states and the Federal Government to limit the ability of local governments to require data. Cities should coordinate with States and consumer protection groups to advocate for stronger consumer data protection laws, such as the GDPR in Europe.

Asset Data: The World Wide Street

Each day, billions of detailed, street-level data points are collected on everything from traffic speeds and volumes to travel patterns and transit use. This data is vital to the operations and management of streets. Street-level data points can be aggregated from a variety of different sources. The graphic at right depicts a selection of the diverse data streams that cities can use to better manage transportation networks and push asset information to users.

The Digital Curb

Curb space has become increasingly digital with the replacement of single-space payment meters by multi-space parking meters and pay-by-app services. As technology advances and cities and their private sector partners figure out how to best deploy new tools, people will gain new ways to use the curb. For example, real-time occupancy information could guide deliveries or ride-hail drop offs.

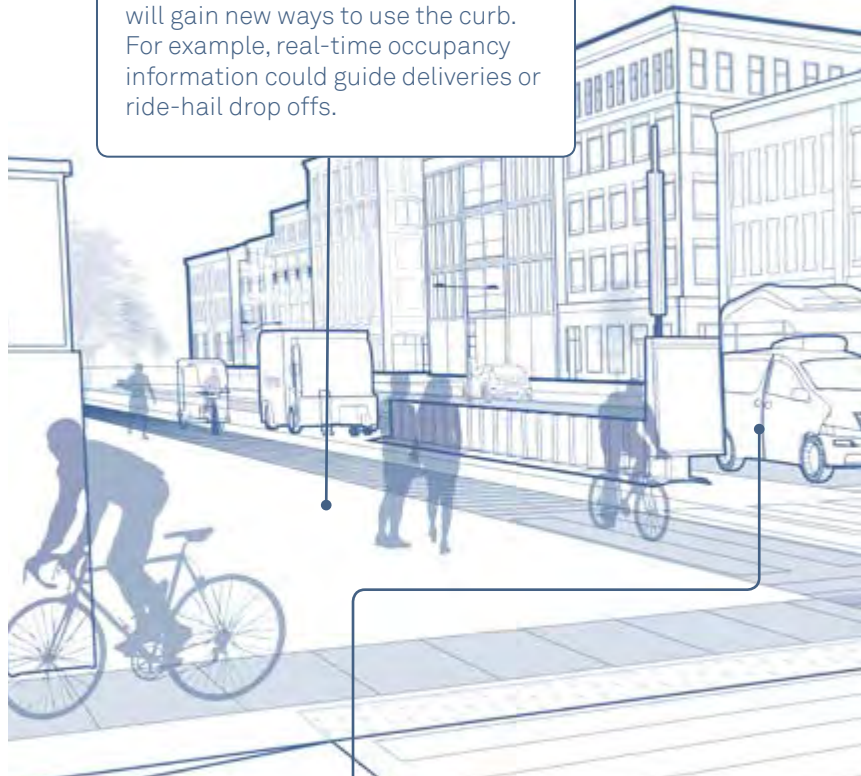

Condition and Parking Occupancy Information

Cities can push real-time information about how street assets are being used, providing people information about the best way to make their trip. As the quantity and quality of data increases, cities are exploring additional layers, such as street closures, safest speeds for given traffic and weather conditions, and curbside uses like package delivery and ride-hail. In an autonomous future, cities could push real-time asset use data to AVs to provide parameters for how they move about the city.

Section 2:

Policies to Shape the Autonomous Age

Counters & Sensors

Real-time counters and sensors can provide vital information about how the street is used. This information can be pushed out to other users to help them make transportation choices. Sensors can also inform signal timing. For example, the “walk” signal duration could be extended crossing a big street just after a full bus lets off passengers. Similarly, counters could recognize the number and speed of approaching bicycles and give cyclists priority at intersections.

Arrival & Travel Times

People make the best choices about how they want to travel when they know how long it will take and how much it will cost them. Transit authorities are already providing real-time arrival information. Routing apps provide information about travel times, parking availability, and costs. Multi-modal apps and on-street information displays can help centralize this information, making it even easier to access and use.

Connected Transit & Signal Priority

The bus is the original connected vehicle. Detectors or location data sent by the bus to either a central traffic management center or directly to the signal controller allows signal timing to be modified in real time to minimize stopping and other sources of transit delay. Networked transit signal priority could allow for better connections and increased reliability across the whole system.

The Path of Journey Data

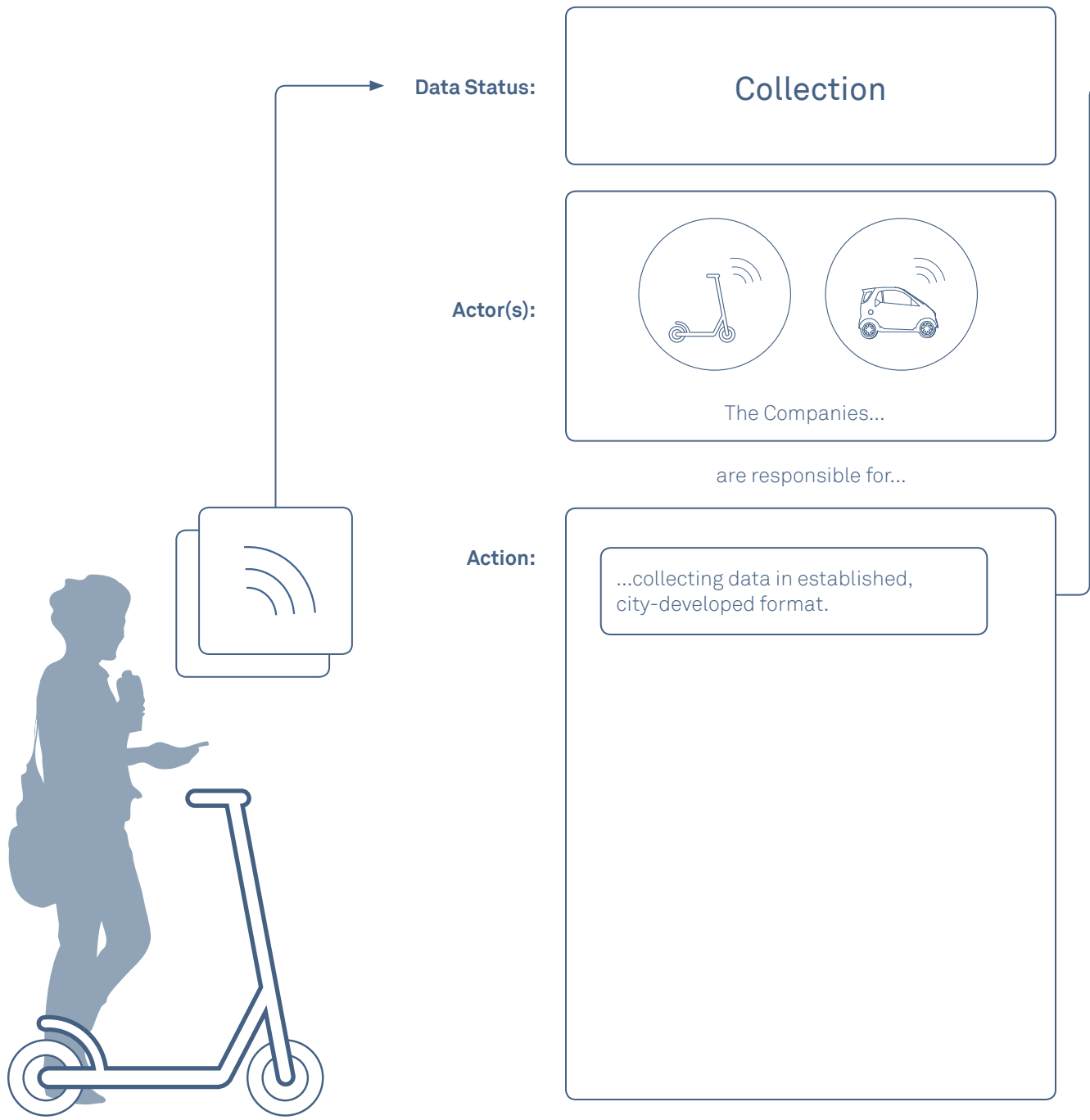

Section 2:

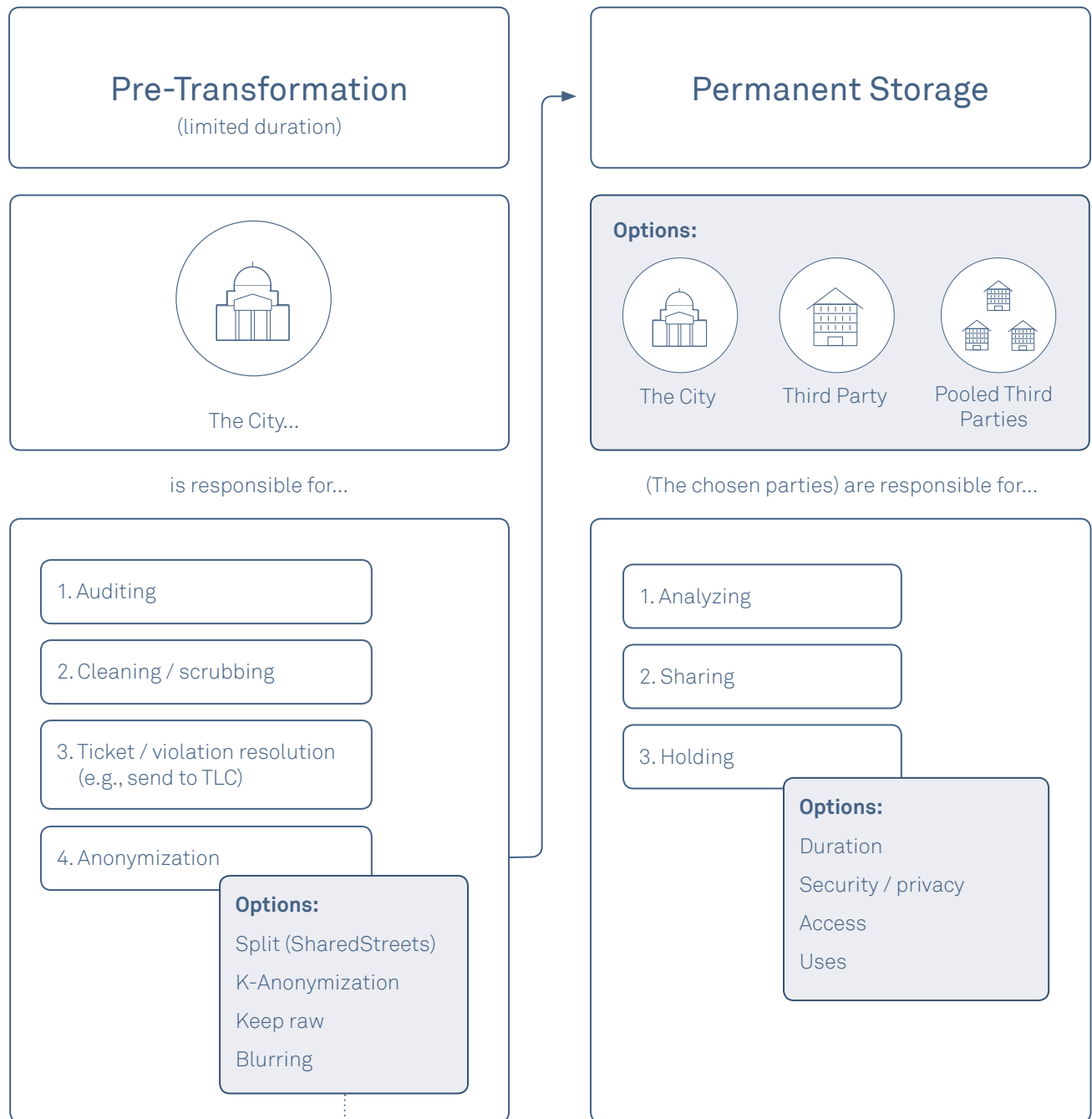

See page 77 for more detail.

The Challenge of Journey Data and Privacy

Regardless of who holds it, journey data poses unique privacy challenges. “Bread-crumbs” data, for example, tracks a person’s movement when location services are enabled on a phone. The GPS unit on the phone “pings” every few minutes or seconds, creating a detailed map of the route a person takes to walk to the grocery store or the speed at which they move. This information can be used to make informed decisions about transit service allocation or safety improvements. However, those same “bread-crumbs” could track a person to the doctor, a political rally, or a job interview. Such information is fundamentally private.

As discussed in *Managing Mobility Data*, a guidance document co-developed by NACTO and IMLA, advances in data science and the huge increase in the volume, precision, and ubiquity of data mean that journey data is or can easily become personally identifiable information (PII). This happens in two ways:

Recognizable Travel Patterns – Even in anonymous datasets, people can be easily re-identified from their routine travel patterns – e.g., from home to work, school, stores, or religious institutions. The 2013 Scientific Report article, “Unique in the Crowd: the privacy bounds of human mobility” found that, in a dataset of 1.5 million people over 6 months, and using location points triangulated from cellphone towers, “four spatio-temporal points are enough to uniquely identify 95 percent of the individuals.”⁶²

Combined With Other Data – Journey data can be combined with other data points to become PII. For example, taken by itself, a single geospatial data point like a ride-hail drop-off location is not PII. But, when combined with a phonebook or reverse address look-up service, that data becomes linkable to an individual person. For example, in 2014, a researcher requested anonymized taxi geo-location data from NYC Taxi and Limousine Commission under freedom of information laws, mapped them using MapQuest, and was able to identify the home addresses of people hailing taxis in front of the Hustler Club between midnight and 6 am. Combining a home address with an address look-up website, Facebook and other sources, the researcher was able to find the “property value, ethnicity, relationship status, [and] court records” of individual patrons.⁶³

Today’s data management choices will impact the world we live in tomorrow. The public and private sectors alike should look to develop data practices and policies that increase the amount of information available for planning and policy making, while simultaneously increasing privacy protections and ensuring that data is protected and managed appropriately.

On the public sector side, cities must strengthen their data management and analysis capacity, recognizing that not all data analysis or aggregation methods are the same when it comes to protecting privacy or providing useful policy-making or planning information. Cities should also retool procurement and development processes to prioritize open standards to avoid getting locked into proprietary systems that may be unsuited to properly address privacy or planning and regulatory needs. As cities gather additional essential mobility data, they should work to educate lawmakers and attorneys on the ease with which mobility data can become PII to prevent inappropriate disclosures.

As the age of autonomous vehicles approaches, revelations about the data (over)-collection and loose handling practices of internet giants like Facebook⁶⁴, Google⁶⁵, and The Weather Channel⁶⁶, should be treated as a wake-up call. U.S. citizens lack federal-level data privacy protections, creating a state-by-state patchwork for protection. In response, calls for a “data bill of rights” are mounting.

The European Union’s General Data Protection Regulation (GDPR) provides a good example of active government intervention to address privacy. First enacted in 2016, the GDPR defines basic protocols for protecting a person’s privacy, including guidelines to limit the over-collection of data, rules for informed consent, and policies for anonymization, storage, and access. The GDPR is meant as a safeguard against the abuse of data by both private and public actors, who may be able to access personal information for personal use, abuse, or enforcement.

Data Anonymization Methods

Different data anonymization methods produce different results for analysis and privacy.

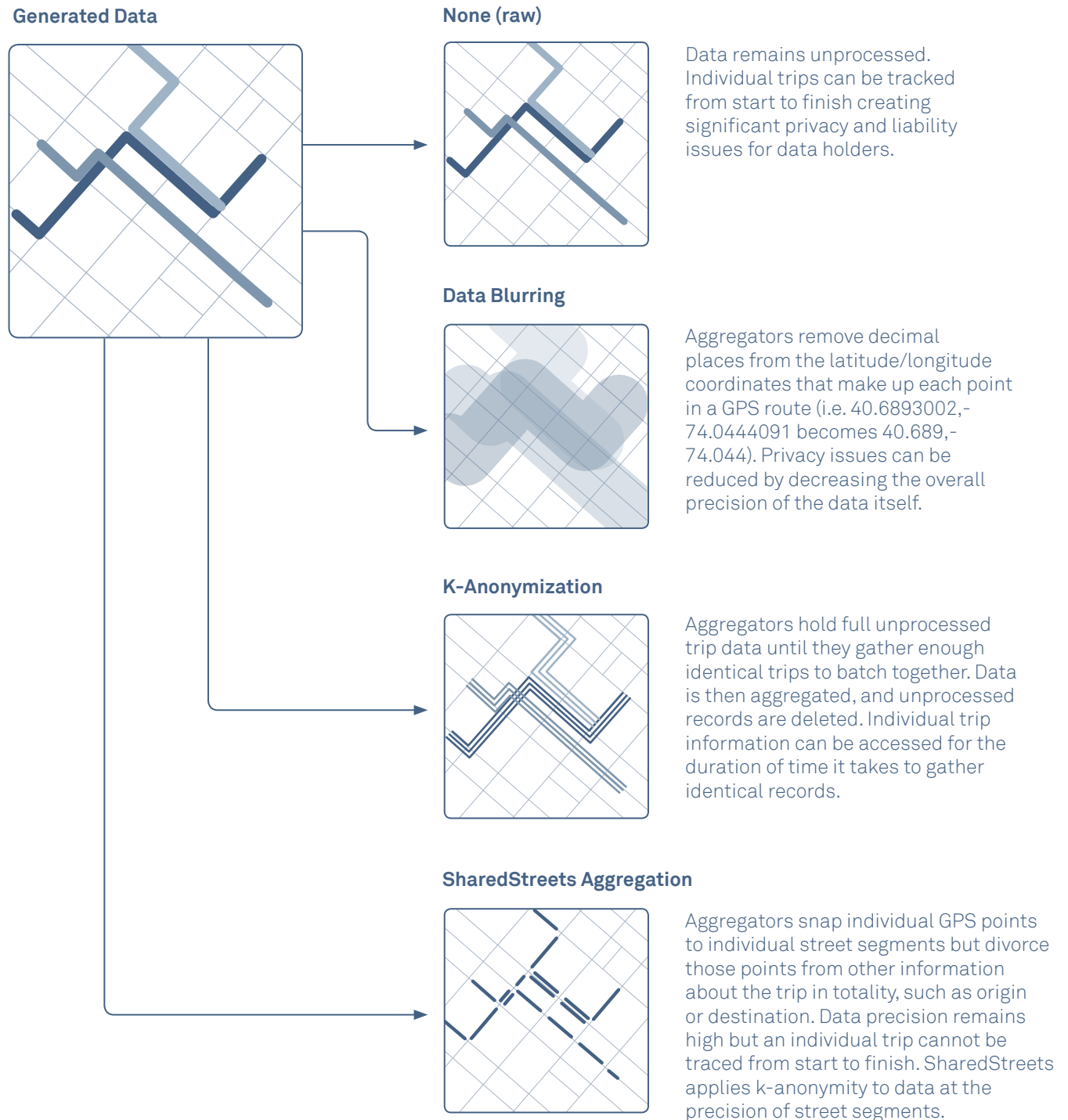





Photo: Tomtek Photography
for Team London Bridge
(London)

2.4

Urban Freight

Freight Opportunities in the Age of AVs.....	82
Labor in the Age of AVs.....	84
Human-Scaled Freight.....	85
The Future of the Curb.....	86
The Challenge of Micro-Freight Devices.....	87

2.4

Urban Freight

Urban freight delivery is critical to the functioning of our cities. Supermarkets and restaurants need deliveries so that we can eat. Package services to the curb or to office loading docks are driven by deliveries that we request. Reliable, consistent delivery service allows cities to grow and thrive.

Largely driven by same-day and just-in-time delivery, the quantity of urban freight is growing rapidly. By 2020, the total number of annual packages delivered is expected to increase to 16 billion, up from 11 billion in 2018.⁶⁷ Coupled with growth in urban driving caused by ride-hail services, overall congestion is increasing. Experts estimate that, in 2016 alone, truck drivers spent 1.2 billion hours sitting in traffic at a cost of \$74.5 billion in additional operations costs.⁶⁸ Unmanaged, automation could propel that to unsustainable levels. To prepare for an autonomous future, cities must develop sophisticated urban freight policies that prioritize and group deliveries to reduce the number of freight trips and increase efficiency and safety.

Automation offers unique opportunities for the movement of goods. Automated rail service, augmented by coordinated autonomous trucks, could transport goods cross-country. Incentivized and managed by thoughtful pricing and other coordinated policies, automated freight vehicles could drop goods at consolidation points at the edge of the city, transferring their packages to smaller vehicles and electric/human-powered delivery trikes. These smaller, city-scaled vehicles could then enter dense urban areas and take packages

Cities must develop sophisticated urban freight policies that prioritize and group deliveries to reduce the number of freight trips and increase efficiency and safety.

the last mile and the last 50 feet to the customer's door. Already, such policies are being tested; a recent survey of light electric freight vehicles in Amsterdam identified a variety of delivery consolidation structures and companies using e-trikes to make urban deliveries.⁶⁹

Alternatively, autonomous freight could exacerbate dystopian outcomes. Autonomous, high-speed long-haul platoons of trucks could increase dangers on roads and highways. Uncoordinated autonomous delivery services could flood sidewalks with bots, making walking increasingly difficult and unpleasant. Drone delivery could significantly increase noise pollution and add a new dimension of chaos to urban streets.⁷⁰ The freight industry employs over 2% of the total US workforce⁷¹, creating potential for widespread unemployment if workforce transition programs are not developed. Comprehensive coordination is essential to avoid this future.

Cities should...



Consolidate Based On Destination, Not Carrier

Today, most deliveries are organized by who is delivering it, not where it is going. As a result, especially in large office buildings, multiple carriers may serve the same building at the same time, adding unnecessary congestion to city streets. As is already in practice in parts of Europe, cities and their private sector partners should incentivize the creation of consolidation facilities that allow multiple delivery services to bring goods and packages to centralized locations. From there, packages going to unique or adjacent addresses can be combined into one shipment and delivered by e-bike or small delivery AV.



Off-Peak Delivery

Most commercial delivery and some portion of office delivery is regularly scheduled deliveries. To reduce freight congestion, cities and operators should use time-access pricing and incentives to reassign these to less congested times. In addition, shifting predictable deliveries to off-peak hours opens up space and opportunities for more urgent or unpredictable deliveries. Off-peak delivery could be combined with consolidation centers, which could help schedule last-mile delivery at workable times, especially for small businesses who might not have night staff.



Down-Size Freight Vehicles

Today, most trucks are too big for urban settings. Their size reduces their maneuverability on the street and makes it hard to find space for loading or unloading. As cities prepare for AVs, they should explore regulation and incentives to encourage companies to down-size their fleets, and prioritize smaller vehicles in municipal fleet purchases. Already, companies like UPS are piloting delivery services with electric bicycles. Similarly, commercial vehicles are adopting existing lower-level automated systems to enhance vehicle safety. In 2015, the European Union required all heavy goods trucks to employ these automatic emergency braking and lane keeping assist to reduce the risk and severity of collisions.



Develop A Curbside Asset Database

The key to managing freight is managing the curb. Cities should develop an active curbside asset database showing the location and size of existing loading zones, curb cuts, hours of operation, and other pertinent infrastructure, markings, and signs. Cities should also build data sharing agreements and partnerships with the private sector to conduct freight flow analyses to understand city and regional freight movements, including different types of deliveries and truck traffic flows.

Freight Opportunities In the Age of AVs

Long-Distance Freight

For long-distance freight movement, autonomous technologies offer a number of efficiency advantages, allowing companies to move goods at all hours without increasing labor costs. For rail and truck freight, goods could be unloaded at strategically located depots in and around the city, to be consolidated into local deliveries.

Freight rail, in particular, is ripe for automation. Rail freight runs on a fixed track in a designated right-of-way, reducing the need for many of the peripheral awareness sensors that are essential for more complex environments like streets or highways. Already, precursor technologies, like positive train control which stops or slows trains when an obstacle is detected ahead, are in use.

For trucking, automation is further off. A number of companies in the U.S. and Europe are testing platoon systems for long-distance freight. Volvo, for example, is working on an automated tractor-trailer for repetitive long-haul operations.⁷² As an interim step, before fully-automated platoons are on the highways, many companies anticipate using a human-driven vehicle at the head of a convoy to handle acceleration, braking, and steering, with automated vehicles following behind.

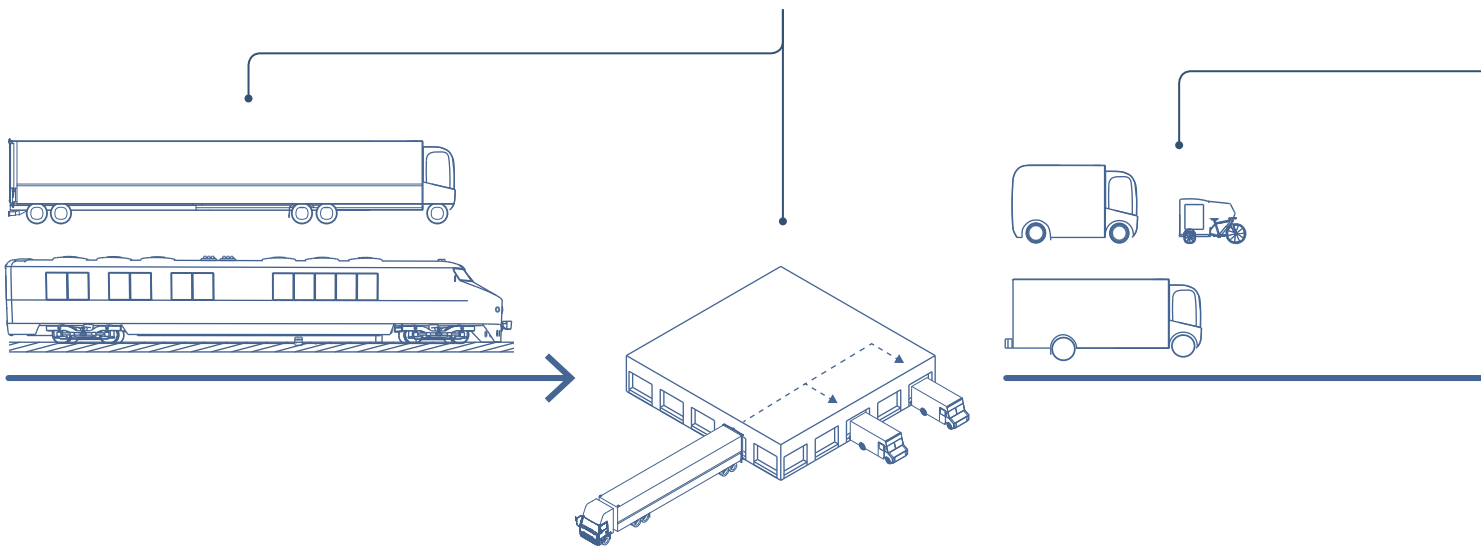

The Last Mile

To handle the complexities of city streets, urban freight will likely best be handled by people using a combination of small AV-assisted and human-powered/electric vehicles. Supporting local freight delivery with automation and downsized vehicles would increase safety and enhanced route planning and efficiency. Especially in dense urban cores, smaller vehicles may be essential. For example, a central London courier firm found that their e-cargobike employees were capable of making more than 30 deliveries per day, versus 10-12 deliveries for their van-base employees.⁷³

The high volume of commercial and office deliveries — multiple packages going to the same place but delivered by different carriers — shows the need for consolidation points. As is currently being explored in Europe, there are a number of options for how and where freight could be consolidated depending on what goods are being delivered and the frequency of delivery. For example, some companies rely on consolidation hubs outside the city center. Others create multiple mobile hubs by parking larger trucks at strategic locations and then completing individual deliveries via e-cargobike.

The Last 50 Feet

People remain the best solution for the last fifty feet. While a vehicle can use a digital mapping database to find an address, for example, it may have difficulty determining the exact delivery point (that is oftentimes around the back or side of the building). To increase efficiency, human labor can be augmented by electric carts.

The data architecture that underpins AVs has key implications for curbside management and freight as cities develop tools, predictive algorithms, and curbside reservation systems to better manage demand for the curb. For example, the City of San Francisco used sensors and variable meter pricing to create a demand-based parking management system that encourages parking turnover and reduces circling and double-parking. Drivers can find parking spaces via the SFPark app or website. To manage urban freight, cities could develop an SFPark-style system to inform delivery drivers of loading zone availability. Cities could use curbside asset management technology to develop a booking system where trucks can reserve space.

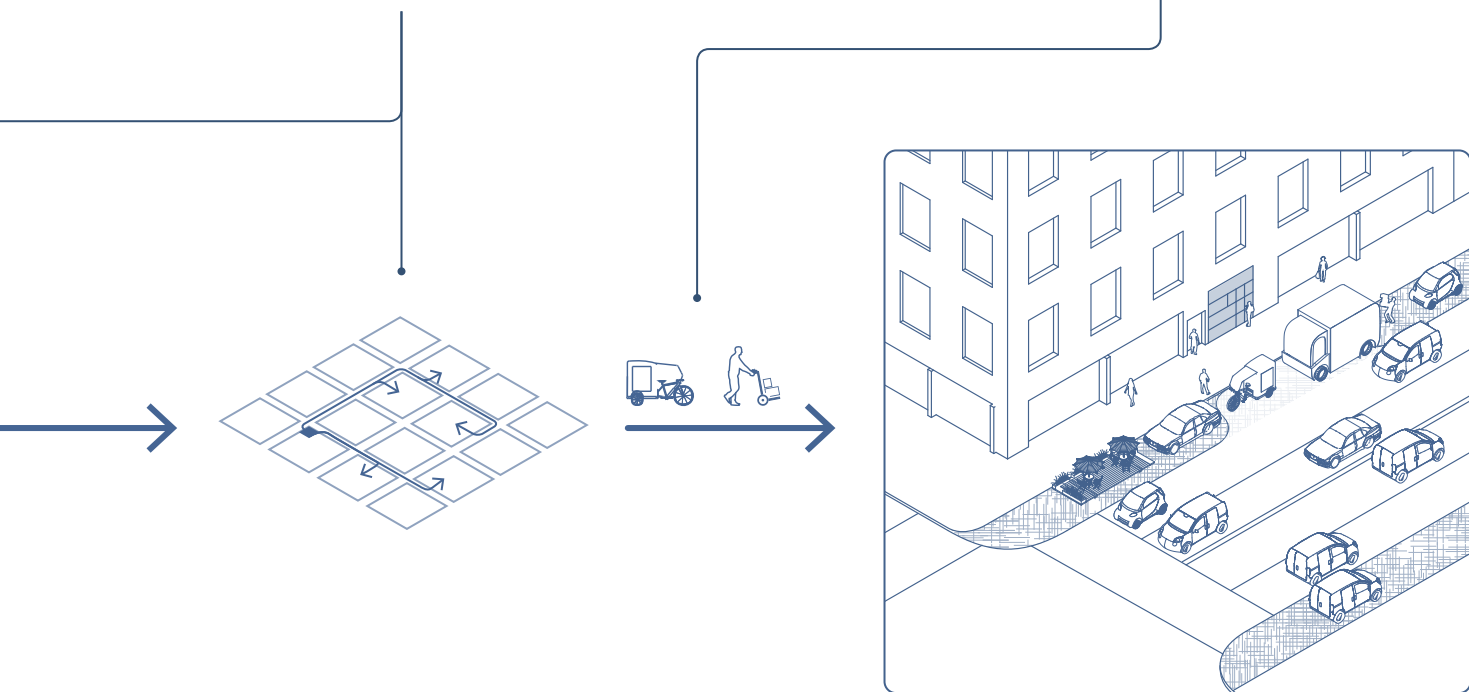

Labor in the Age of AVs

As with transit, the livelihood of the millions of individuals currently employed in the trucking industries is a key issue that must be grappled with in preparation for AVs. Together the trucking, taxi, and ride-hail industries employ almost 3 percent of the total American workforce, providing over 4.1 million jobs.⁷⁴ People of color are overrepresented in this industry, and automation's potential to displace these workers risk exacerbating financial hardship along racial lines.⁷⁵ Along with their federal and state counterparts, city governments have a responsibility to act to avert widespread labor disruption.

For freight, the complexity of urban streets and the nuances of where and how packages are delivered means that jobs created in the last mile and last 50 feet are likely to remain in human hands. However, these jobs may shift and change as AV technologies augment or assist human operations. Companies must act now to ensure that their workforce, and their future workforces, are trained and equipped for the technologies of the future.

Going beyond freight, there is no shortage of policies and programs governments could enact to mitigate the short-term effects of job loss accompanying automation. Cities can begin this process by evaluating the jobs that the AV development trajectory will impact. In the event of larger-scale job losses, cities are also empowered to strengthen the local social safety net by guaranteeing workers automatic unemployment insurance and access to medical care.

Acting unilaterally, cities can support employees driving municipal vehicle fleets by upholding collective bargaining and public sector unions. As a group, cities can advocate for stronger workers' rights and other creative solutions to automation-related labor disruptions such as a progressive basic income and worker ownership over AV fleets and companies.

Photo: NYCDOT



Human-Scaled Freight

Nationally, large trucks comprise 4 percent of the U.S. vehicle fleet, yet are involved in 7 percent of pedestrian fatalities, 11 percent of bicyclist fatalities, and 12 percent of car and light-truck occupant fatalities.⁷⁶ In developing freight management policies to prepare for automation, cities and companies alike have an opportunity to increase efficiency and safety by reducing the size of freight vehicles operating in cities.

On the efficiency side, studies show that shifting to smaller vehicles can increase efficiency by speeding up loading/unloading times. This could increase the value of flex zones and help companies reduce the number of parking tickets they receive. Research conducted in Amsterdam suggests that e-cargobikes can be loaded/unloaded in about 3 minutes, versus a 12 minute average for the same amount of freight from a delivery van.

Similarly, by consolidating freight into smaller vehicles for consolidated last mile delivery, delivery companies may be able to run fewer half-empty trucks. As noted in NACTO's *Optimizing Large Vehicles for Urban Environments* reports, co-produced by the USDOT Volpe Center, on average, trucks in the US operate at anywhere between 50 percent and 90 percent capacity. USDOT reports that empty trucks drive over 20 billion miles per year. Consolidating packages going to the same or adjacent locations may help reduce unnecessary VMT.

On the safety side, reducing the size of freight vehicles has two benefits. First, larger trucks, regardless of if the driver is human or a computer, have slower stopping distances and are more lethal when they hit someone. Today, overall truck size, combined with outdated design features, mean that truck drivers have limited visibility, increasing the likelihood of a crash. Requiring Direct-Vision truck cabs, cab-over designs, and other visibility tools can increase safety now while also creating a new platform for sensor placement for autonomous and AV-assist tools.

Second, large trucks are less maneuverable than smaller ones, requiring cities to accommodate them with overly wide streets and intersections. The wider lanes and larger corner radii reduce safety by encouraging speeding and increasing crossing distances. As freight companies and municipal fleets shift to smaller vehicles, cities can design safer, more vibrant, human-scaled streets.

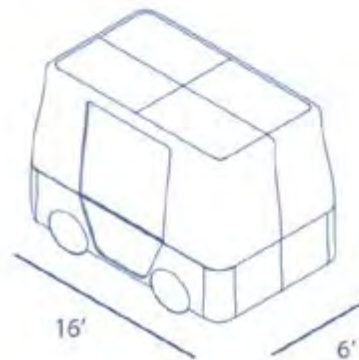
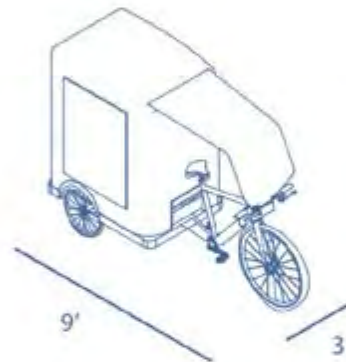

The Future of the Curb

Today

Trucks can legally make deliveries only when a parking space or loading dock is available and open. However, loading docks are often undersized or used for parked cars, trash or storage, making them less reliable than intended. On street parking is first-come, first-served—not prioritized for delivery or essential services.

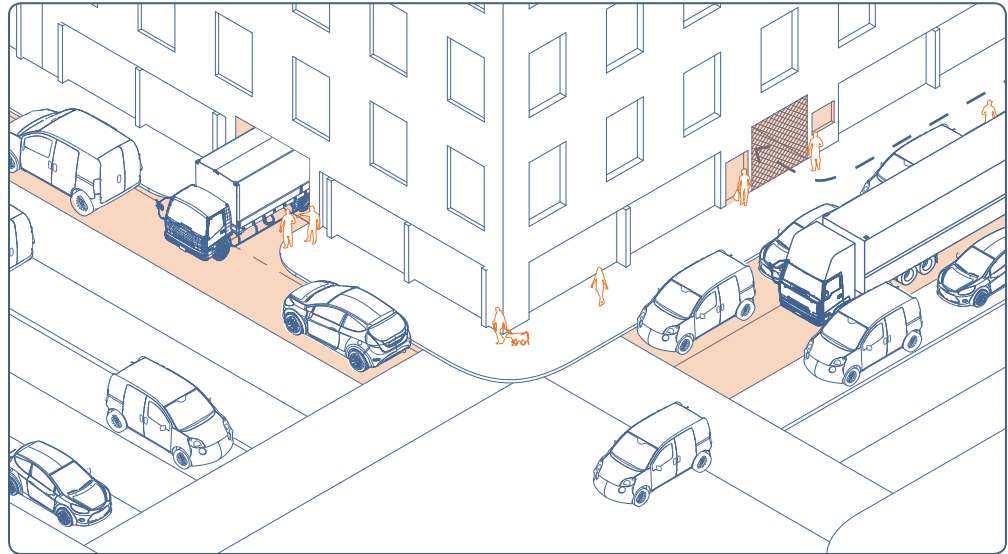

Future

Dynamic curbside pricing can more efficiently manage curbside drop-off and pick-up, creating incentives for both carriers and receivers to reduce their dwell time or risk paying escalating rates. Smaller vehicles increase efficiency and reduce loading/unloading times.

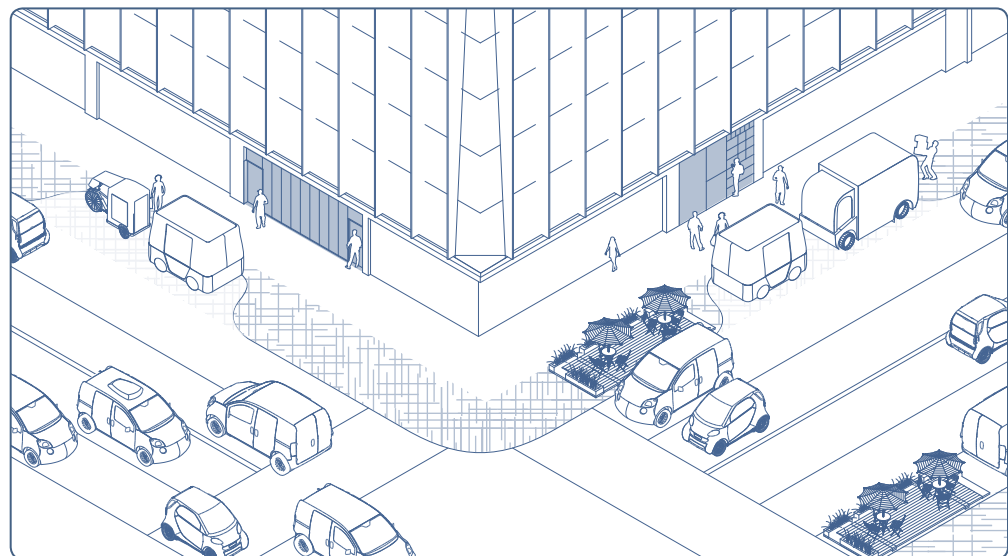

The Challenge of Micro-Freight Devices

Drones: A New Frontier for Cities

Delivery drones, or unmanned aerial vehicles (UAVs), are a relatively new addition to the urban freight landscape. These drones have the ability to deliver lightweight packages and are already used to deliver time-sensitive items such as medicine and blood samples to remote locations inaccessible by other means. In 2016, the Federal Aviation Administration (FAA) began allowing companies to test drones for commercial uses in the US. The agency set a limit on the combined weight of drones and their packages and required a licensed pilot to keep the device within sight at all times.

For cities, the proliferation of drones in urban airspace poses questions about jurisdiction, drop-off logistics, and extending management of the public right-of-way to spaces other than streets. Cities will have to contend with unprecedented noise pollution considering that the average commercial delivery drone is 85 decibels loud, comparable to a gas-powered leaf blower.⁷⁷ While the FAA historically regulates all airspace in the US, cities should take an active role in shaping the drone policy to mitigate potential safety, noise pollution, and space allocation issues.



Photo: Eduardo Famendes

Sidewalks: Not for Bots

Perhaps the most futuristic vision in the freight sphere is the notion of humans and robots sharing the sidewalk as bots the size of picnic baskets and filing cabinets trundle around delivering packages to customers. While states including Virginia, Idaho, Florida, and Wisconsin have relaxed rules to allow these vehicles to operate, San Francisco has notably restricted their use, requiring companies to apply for a limited number of permits and permitting the vehicles only in areas zoned for industrial use.

In dense areas where pedestrian activity is high, bots would likely clog the sidewalk and inconvenience or endanger people on foot. They should be severely restricted if not banned outright. In contrast, these small bots might have a role to play in more controlled environments such as industrial parks or university campuses.



Photo: Starship Technologies



TORY

TELET

de Casa

3

Design for the Autonomous Age

3.1 Streets for Safety.....91

3.2 Curbs for Access.....115





Photo: NACTO (Memphis)

3.1

Streets for Safety

Managing the Future Street	94
Dynamics of the Future Street.....	96
New Rules of the Road.....	98
Safe, Frequent Crossings.....	100
Crossing the Street.....	102
Cycling Through Intersections.....	104
Street Types.....	106
Multiway Boulevard	108
Major Transit Street.....	109
Downtown Street.....	110
Neighborhood Main Street.....	111
Residential Street.....	112
Minor Intersection.....	113

3.1

Streets for Safety

In 2017, car crashes killed 37,133 people in the US. This fatality number has been rising steadily over the past decade, as Americans drive more and drive faster, in increasingly large vehicles. The US has the dubious honor of having the worst per capita fatality rate in the industrialized world; double to quadruple the rate of our Canadian or European counterparts.⁷⁸

The design and management of streets is one of the most powerful tools that cities can exercise to achieve their safety goals, improve transit service, and reduce carbon emissions. In their initial development and deployment, automated vehicles are being programmed to follow a complex set of traffic rules, abiding by the geometries that cities plan, engineer, and construct. This power over street geometry gives cities unique opportunities to shape technology policy.

Cities must seize their chance now to shape new technologies, rather than wait for technologies to shape them. We have made that mistake before. During the early twentieth century, cities embarked on large-scale modernization projects to accommodate cars, reshaping their streets

and public spaces. The landscape created by car dependence led to increased racial and economic segregation, abysmally high traffic fatalities, increasingly long commutes, and rising global temperatures and emissions. Today, 30 percent of all US carbon emissions come from transportation.⁷⁹

To ensure safety in an autonomous age, cities should prioritize high-capacity transit and active transportation. These modes are the foundation of a more urban-oriented vision for the future of transportation. City and state DOTs must reassess long held engineering and planning “rules of thumb” such as level-of-service, 85th percentile, and assumptions about what transit riders want. Using a combination of digital tools that analyze user data and automatically enforce regulations, combined with street design strategies that manage the speed, flow, and directions of travel, cities can regulate their streets according to a sustainable hierarchy of street users and design transportation systems around the needs of people.

Place de la Republique, Paris

Pre-transformation

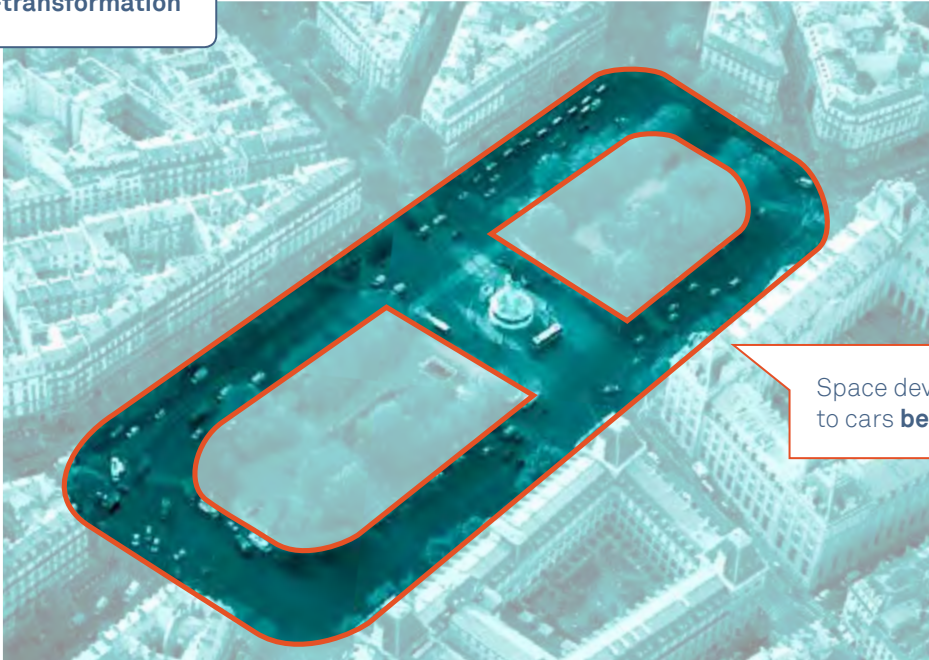

Post-transformation

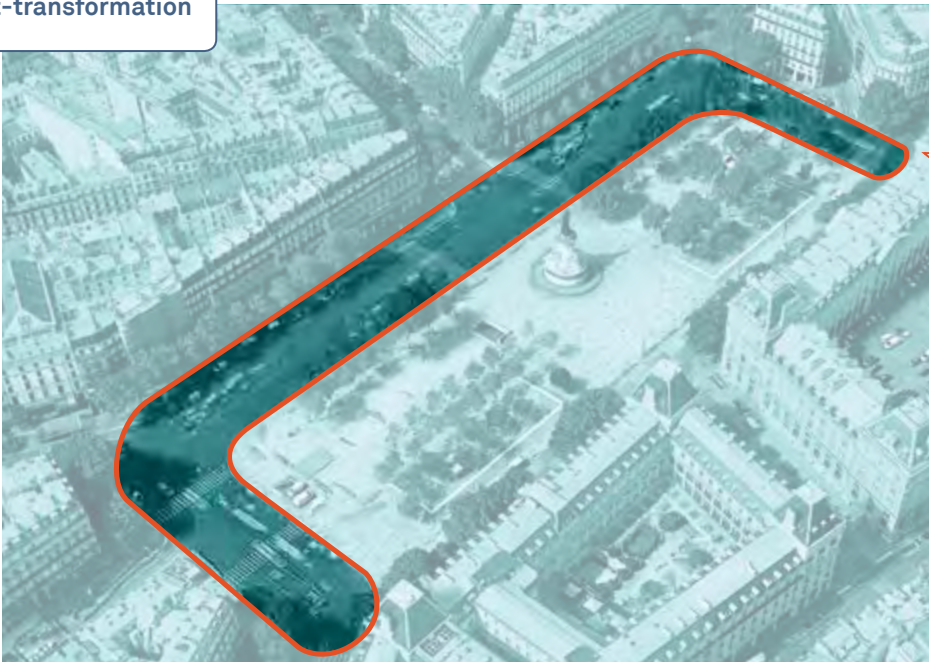

Managing the Future Street

Policies for **Safety and Comfort**

Pedestrians Detected, Not Connected

People walking and biking should not be required to carry sensors or signals to stay safe. Cities should require AVs to detect and yield to pedestrians in all conditions, and to retain full responsibility for not injuring people using the street.

Low, Steady Speeds

To ensure a safe environment for active transportation modes, cities must actively manage speeds. Speeds should be limited to 25 mph citywide and lower (typically 15 to 20 mph) in city centers, residential areas, and near schools and other sensitive locations.

Places to Rest

Plazas, parklets, and pocket parks provide places for people of all ages and abilities to stop, congregate, and spend time.

Children Are the Design User

Cities should design streets to meet the safety and mobility needs of a small child. By reducing vehicle speed, shifting people away from car trips, and increasing the visibility of the people most vulnerable to traffic violence, cities can make streets safer for all.

Policies for **Efficiency and Growth**

Transit First

Cities should allocate street space to prioritize transit and other high-efficiency modes. High-frequency, reliable routes, made possible by bus-only lanes, transit signal priority, and AV technologies can ensure that in the future, success is measured by moving people, not vehicles.

Real-Time Street Data Collection

Cities should collect data from AV and other vehicles operating on their streets to manage streets in real-time. This information can pinpoint hazardous locations and direct resources towards redesigning streets for safer and more efficient operations.

Curbside Demand Management

Cities should adopt policies to allow the curb to serve different functions over the course of the day. Curbside inventories and demand-based pricing will allow curb access to be managed and prioritized in real-time.

Congestion Pricing

Pricing will play a key role in the autonomous future. Cities and states should implement pricing policies to reduce driving and mitigate the safety, health, environmental, and economic burdens of single-occupancy car use.

Places for Commerce

Increased street efficiency will lead to improved economic outcomes for individuals, neighborhoods, cities, and regions. With flex zones, curbside pricing policies, and increased space for pedestrians and vendors, cities can create opportunities for businesses of all sizes.

Tools for **Safety and Comfort**

Narrow Lanes

Narrow lanes reduce speeds. Lane widths should be 10' or less in most urban contexts. Lanes on streets without large transit vehicles can often be narrower.

Smaller Municipal Vehicles

Emergency and municipal vehicle needs often dictate street design decisions. Using smaller street sweepers, plows, and emergency vehicles creates opportunity for safer street design.

Tight Corner Radii

Small corner radii at intersections increase safety. Smaller radii can be achieved by selecting the smallest possible design vehicle, accommodating trucks and buses on separate routes, and restricting right turns on red.

Frequent Pedestrian Islands & Stopping Points

Pedestrian islands increase safety. They should be installed wherever people must cross three or more lanes of traffic.

Diverters and Mini-Roundabouts

Diverters and mini-roundabouts slow vehicles and help prioritize key modes such as transit and bikes.

Tools for **Both**

Sensors and Street Technology

Sensors and other data collection devices gather real-time information that can inform pricing and street space allocation decisions.

Protected Bike Networks

Robust, connected, and citywide bikeway networks make cycling an option for all ages and abilities.

Pedestrian Plazas

Plazas in street space reclaimed from vehicles provide places for people to walk, rest, shop, and socialize.

Tools for **Efficiency and Growth**

Bus-Priority/Bus-Only Lanes

Reallocating travel lanes to transit use improves bus operations and reduces travel times.

Better Bus Stops

Boarding bulbs and islands improve transit operations by allowing buses to stop in-lane. Shelters, lighting, and real-time information displays improve rider safety and comfort.

Time of Day Management

Demand-based tools allow streets to serve different purposes at different times of day. High pedestrian activity may trigger closures for vehicles, speed reductions, or re-routing.

Green Infrastructure

Bioretention planters, swales, and permeable paving materials manage stormwater in the street, improve water and air quality, cool urban surface temperatures, and improve the public realm while supporting calmer streets.

Mobility Hubs

Mobility hubs link multiple transportation options at key locations, providing opportunities for transfers and increasing efficiency across the transportation network as a whole.

Dynamics of the Future Street

In the autonomous age, streets must give ultimate priority to pedestrians, bicyclists and transit riders. Smaller and fewer lanes can minimize conflicts and crossing distances for pedestrians and allow space for robust bicycle infrastructure on all streets. Transit, the backbone of the urban mobility system, has priority operation in dedicated lanes. Flexible curbsides allow for a myriad of public and private uses—from loading zones to parklets. Street design and AV programming restricts speeds to safe levels of 25 mph citywide and typically lower (15 to 20 mph) in downtown cores, residential areas, and near schools and other sensitive areas.

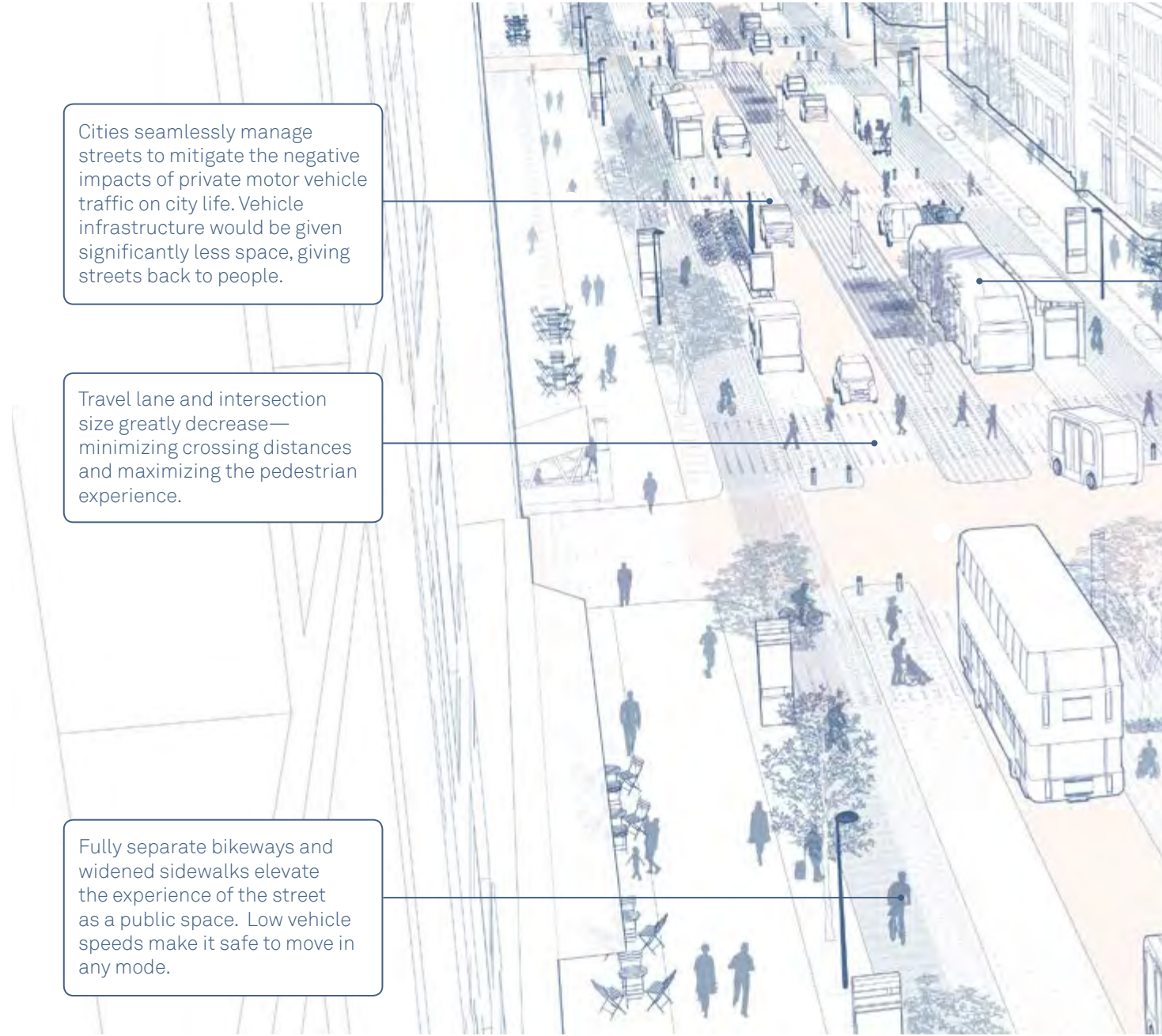
An aerial perspective illustration of a future city street. The street is wide and features a central transit lane with a double-decker bus. Pedestrians are walking on wide sidewalks, and a cyclist is riding on a dedicated bike lane. The street is lined with trees and modern buildings. Three callout boxes with lines pointing to specific areas of the street provide text descriptions of the design elements.

Cities seamlessly manage streets to mitigate the negative impacts of private motor vehicle traffic on city life. Vehicle infrastructure would be given significantly less space, giving streets back to people.

Travel lane and intersection size greatly decrease—minimizing crossing distances and maximizing the pedestrian experience.

Fully separate bikeways and widened sidewalks elevate the experience of the street as a public space. Low vehicle speeds make it safe to move in any mode.

Section 3:

Design for the Autonomous Age

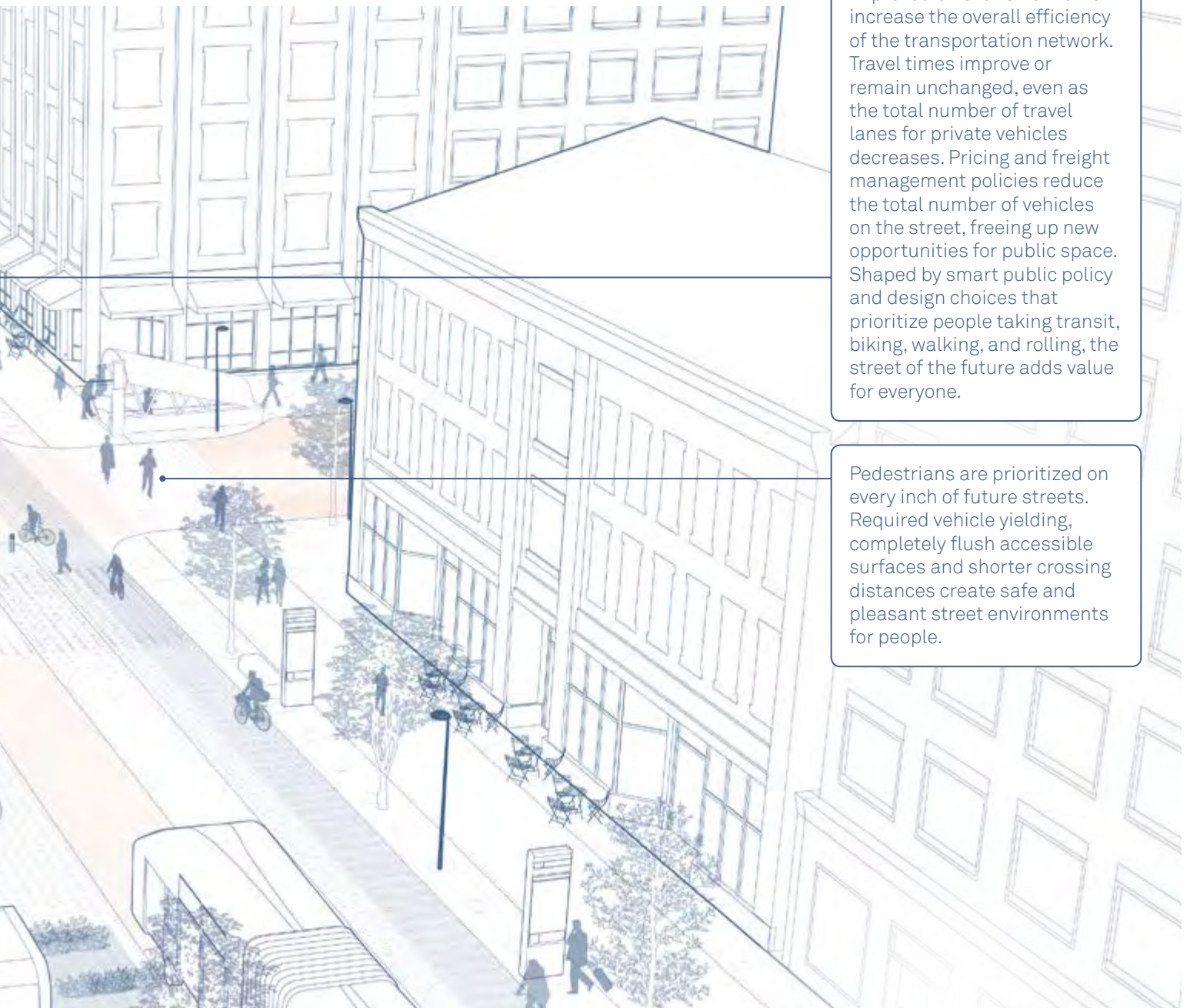

Dedicated transit lanes and improved bike lane networks increase the overall efficiency of the transportation network. Travel times improve or remain unchanged, even as the total number of travel lanes for private vehicles decreases. Pricing and freight management policies reduce the total number of vehicles on the street, freeing up new opportunities for public space. Shaped by smart public policy and design choices that prioritize people taking transit, biking, walking, and rolling, the street of the future adds value for everyone.

Pedestrians are prioritized on every inch of future streets. Required vehicle yielding, completely flush accessible surfaces and shorter crossing distances create safe and pleasant street environments for people.

New Rules of the Road

A shift in transportation technology presents an opportunity to rethink long-held assumptions about how streets operate and how cities manage their traffic flows. Traffic signals, curbs and striping were products of the last revolution in mobility. They became widespread and standardized only after a period of flux and uncertainty. The advent of automated vehicles presents a chance to question the modern rules of the road and to consider new possibilities for street operations, infrastructure and design.

More Frequent Crossings

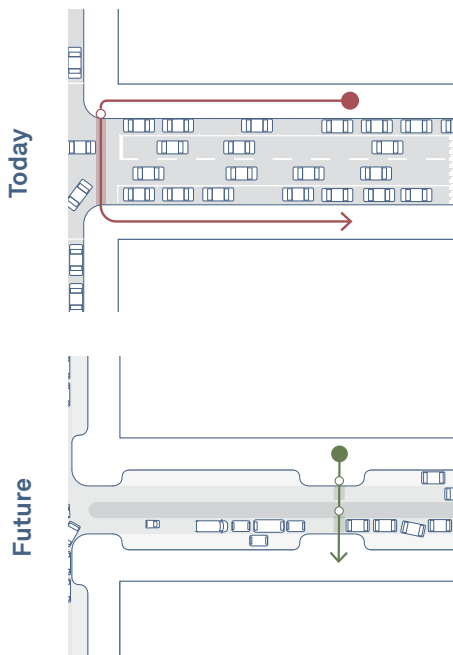

Present-day traffic operations focus primarily on conflict points at or near intersections. In the era of automation, the intuitive act of crossing directly to one's destination—known technically as mid-block crossing—could become normal once again. Frequent, formal midblock crossing points (every 50–100 feet), coupled with sufficient gaps in AV traffic, would relieve bottlenecks at intersections, while accommodating pedestrian desire lines more seamlessly.

Stopping Distances

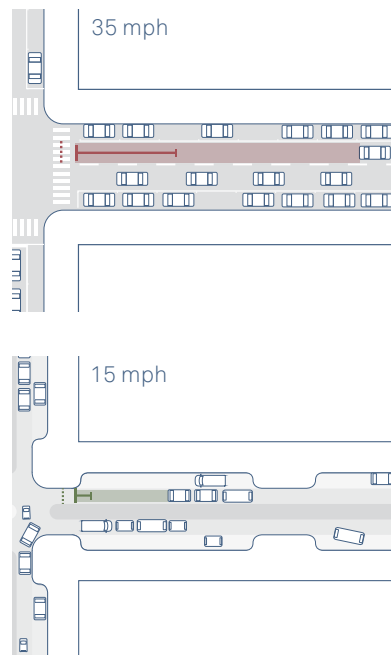

To ensure a safe street environment for all street users, speeds can be actively programmed, managed, and limited to 25 mph citywide and 20 mph or less in city centers, especially where bicycling or transit are not fully separated from other motor vehicles. Vehicle coordination, decreased traffic volumes, and lack of signal delay would provide consistent, reliable movement.

Vehicle Spacing

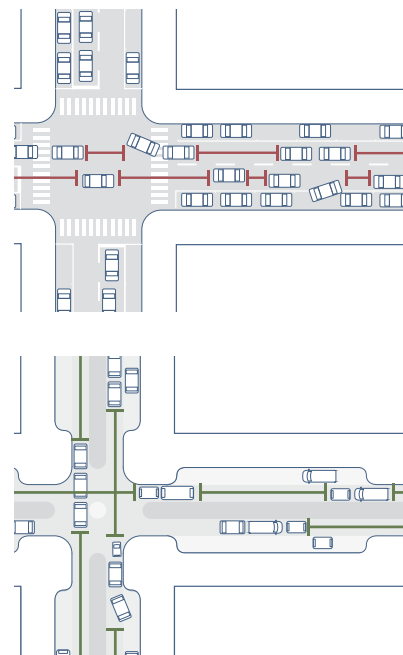

Cities must avoid creating impassable, highway-like arterials with endless platoons of traffic. With more passenger consolidation into multi-use vehicles, pedestrians could have safer, more frequent crossing opportunities than traditional signalization can provide, achieving both safety and operational goals.

Roundabouts and Diverters

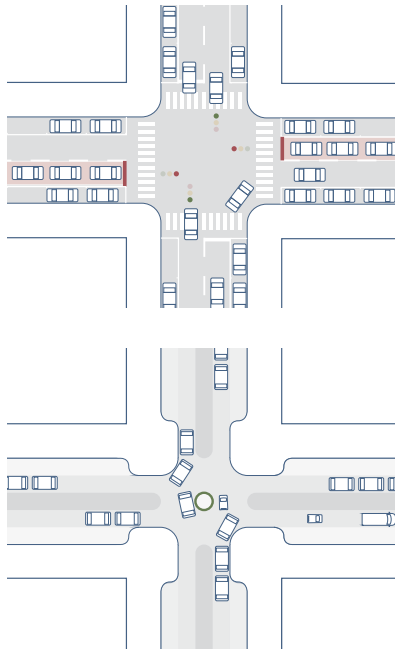

In a connected and automated vehicle environment, intersections accommodate more fluid streams of traffic. Certain types of intersections, especially at minor crossings, behave more like roundabouts with consistent, slow traffic as opposed to persistent stop-and-go movement. Cities must use street design tools to allow certain modes while discouraging others.

Pick-up and Drop-off

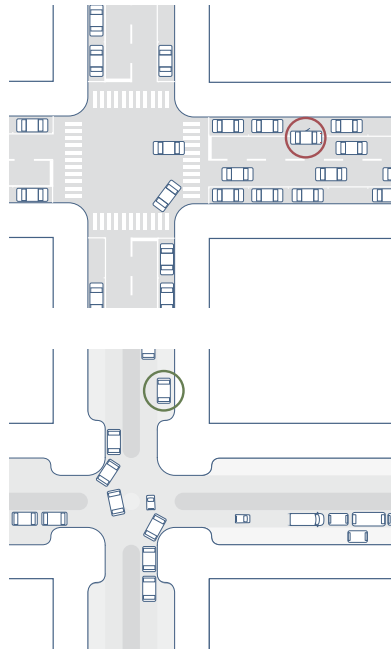

To drop off passengers, vehicles on major streets will first turn right. Turning off of the main street to stop reduces congestion on main corridors and allows more space along the curb to be dedicated to other uses. Where bicycle traffic is heaviest, right turn pick-ups and drop-offs may be less ideal.

Shorter Crossing Distances

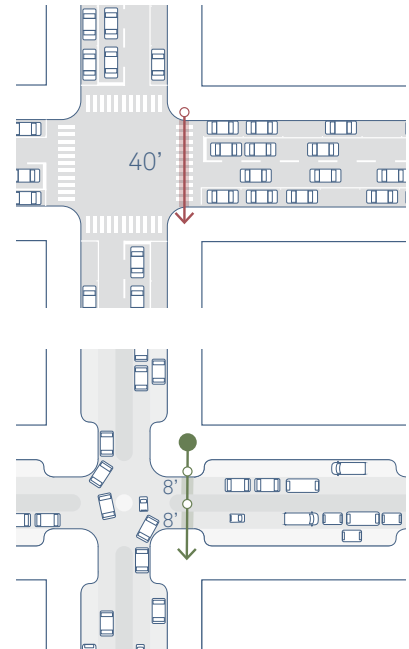

Streets with narrow lanes and medians allow for shorter crossing distances and frequent refuge.

Safe, Frequent Crossings

Today

People incur significant delays while walking to their destinations. Long signal lengths and infrequent or poorly spaced crosswalks increase both the time and distance to cross the street, making walking undesirable in some places.

In the future, streets could prioritize pedestrians through software and infrastructure.

Legend

- Safe Zone
- Wait Zone
- Exposure Zone

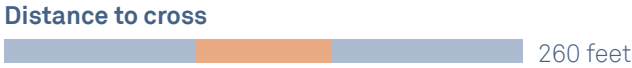
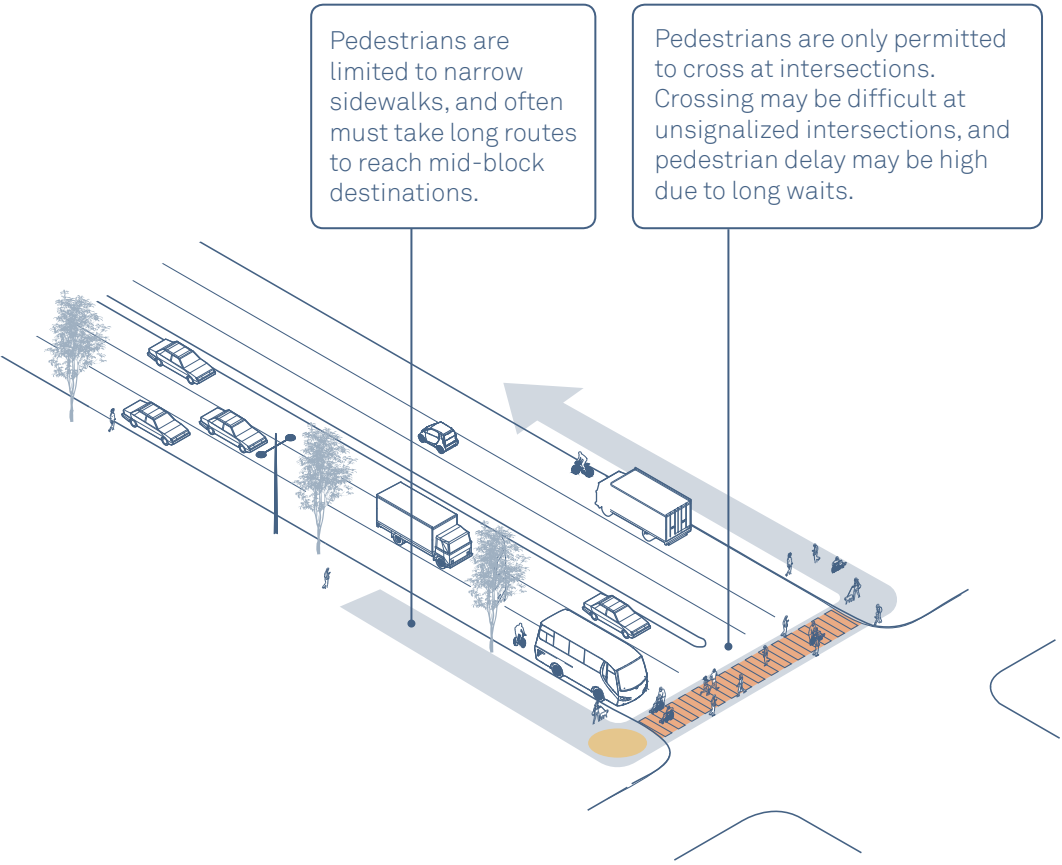

Tomorrow

On the streets of tomorrow, people rule the road. Vehicles should be optimized to travel at consistently slow speeds, allowing for pedestrians to safely cross streets at close intervals. Fewer lanes and crossing distances would make it more convenient and quicker to get to destinations on the other side of the street. The instinctive human act of walking straight to one's destination, pejoratively known as "jaywalking," becomes simply "walking."

Pedestrians would be able to cross almost anywhere along the street. Medians can provide space to wait between vehicles, and slow travel speeds would make crossing easy and safe.

More space would be dedicated to pedestrians, and additional amenities like seating and kiosks would enliven the streetscape.

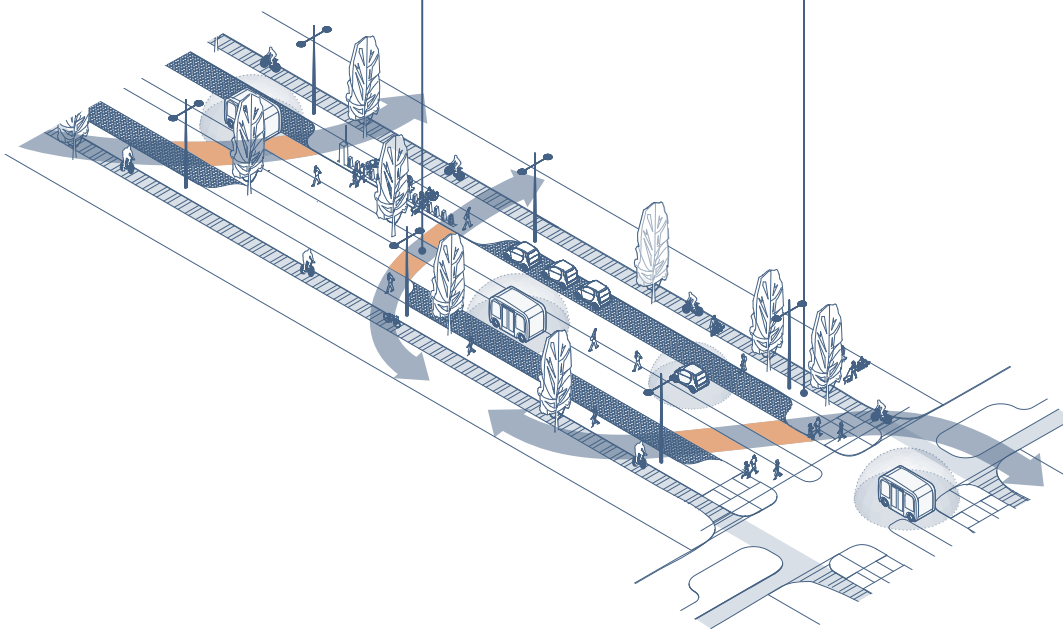

Distance to cross
80 feet

Time to cross
23 seconds

Crossing the Street

Today's streets are characterized by missing sidewalks or curb ramps and uneven surfaces, rendering many parts of the city completely inaccessible. By providing flush surfaces, regular gaps in platooning vehicles, and medians for refuge, future streets can be accessible for all street users.



A person who uses a wheelchair is leaving a café table in the middle of the block, and wants to cross the street to meet a friend.



He looks left and crosses the bikeway, which is level with the sidewalk, feeling a slight rumble over the textured edge between the two.

He waits briefly before crossing the low-speed flex zone lane, while a vehicle carrying freight pulls away slowly from nearby. The truck has detected that people are moving toward the lane, and has slowed to 10 mph to stop quickly if needed.

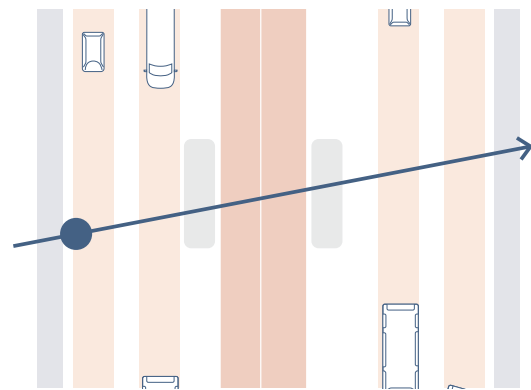
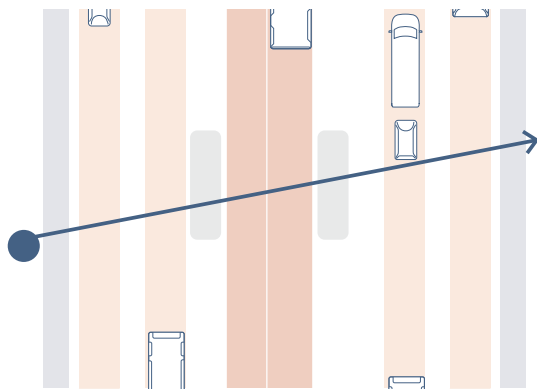

Section 3:

Design for the Autonomous Age

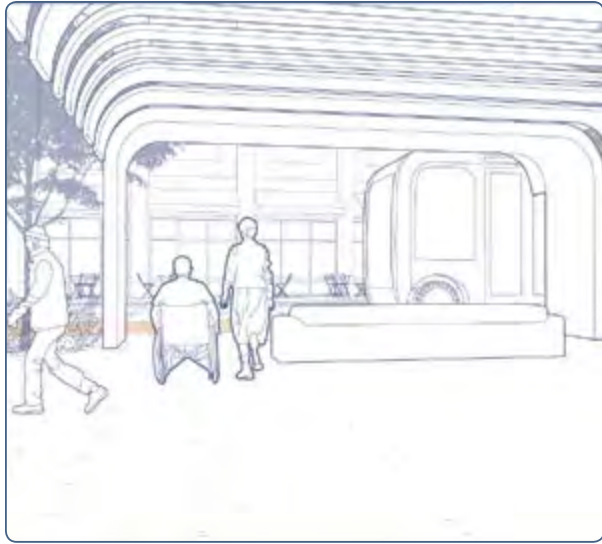

He crosses the flex zone and proceeds to cross the main vehicle lane. Seeing that approaching vehicles are still relatively far away, he begins crossing, but his wheels hit a piece of litter and he slows down. A vehicle approaching senses that he might still be in the lane if it continued at its current speed, and slows slightly from 15 to 10 mph to keep a longer distance between them.



He proceeds through the transit lanes after waiting for the bus to pull away. He sees that there is a gap in the main vehicle lane and that all vehicles are stopped in the flex zone lane. He crosses the rest of the way at a normal speed, reaching the other side of the street to meet his friend.

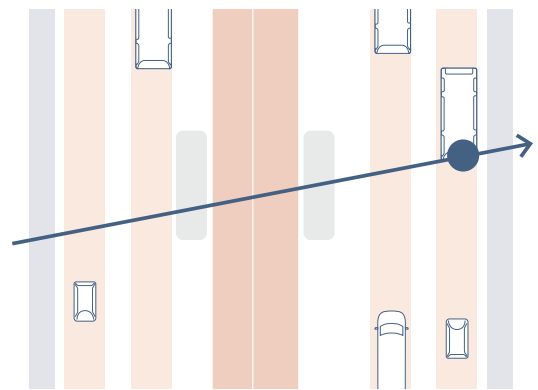
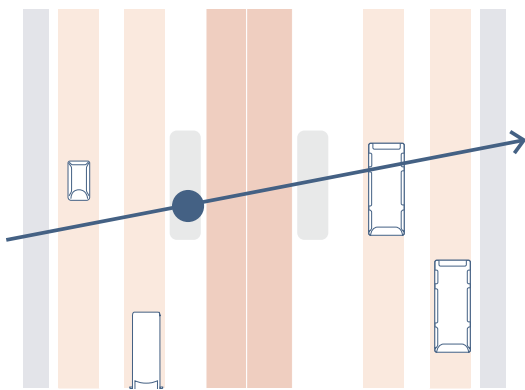

Cycling through Intersections

In the future, bicyclists and autonomous vehicles could interact seamlessly. Today, right hook collisions (when a right-turning vehicle hits a bicyclist continuing straight) are frequent and deadly. AVs must sense and prepare to yield to cyclists before the vehicle enters the intersection.

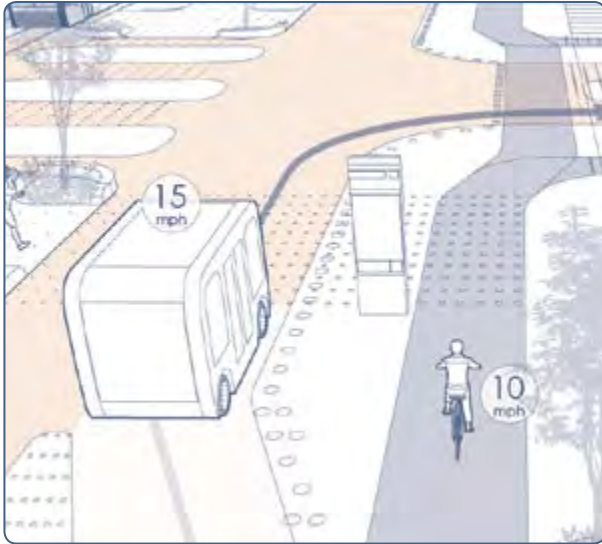

As the cyclist approaches the intersection, she is passed gradually by an automated shuttle that intends to turn right. The shuttle detects and tracks her movement, and slows as it approaches the intersection.

An audible signal is flashing yellow, giving the shuttle permission to continue with caution, which the bicyclist can see and hear. During this phase, vehicles are permitted but must yield to one another and to people. These intersection controls also have a pedestrian-and-bike-only phase. The shuttle has been tracking a jogger on the left, but has calculated that she'll just be arriving at the crosswalk when the shuttle passes.

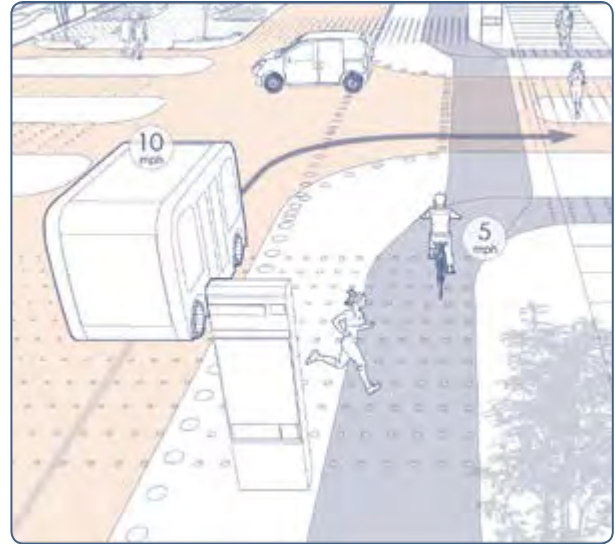

The bikeway curves to the right, creating space for a vehicle to wait as indicated by a yield line in the pavement. As the bicyclist gets close to the intersection, the shuttle slows to a crawl to be ready for an instant stop as it approaches the crosswalk—since the bicyclist might turn left, too. It anticipates that she will probably go straight, and sets its speed so it can stop within three feet (usually 7 mph).

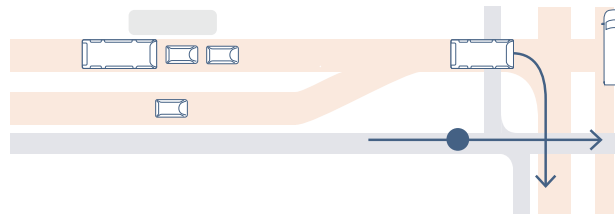
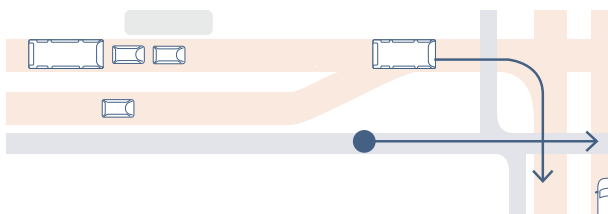

Section 3:

Design for the Autonomous Age

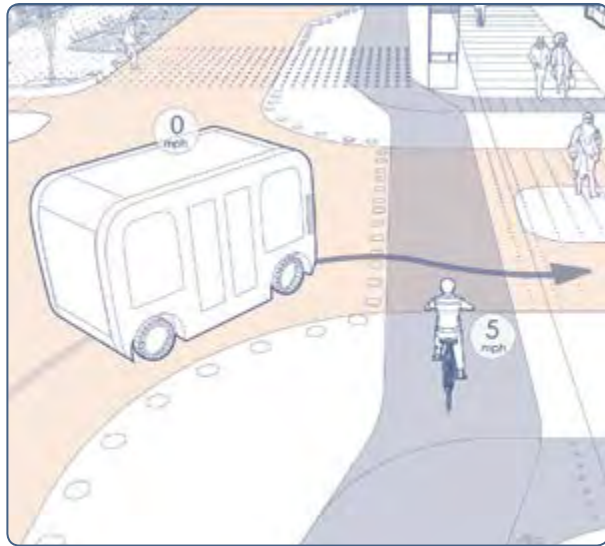

Seeing that there is no other cross-traffic, the bicyclist goes straight and the shuttle waits for her and the pedestrians in the crosswalk. The shuttle's routing algorithm anticipated that it will usually need to pause here.

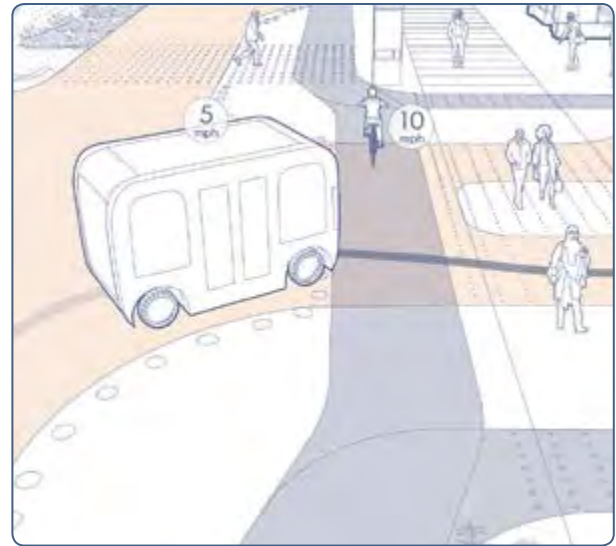

The bicyclist proceeds, seeing as she crosses the median that vehicles coming from her right also slowed. The group of people in the crosswalk finish crossing the street, and the shuttle proceeds.

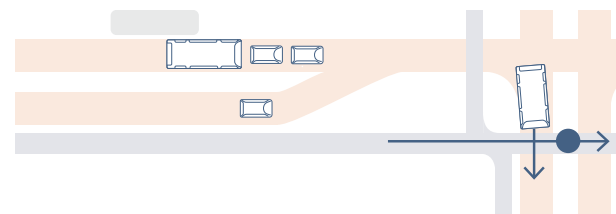
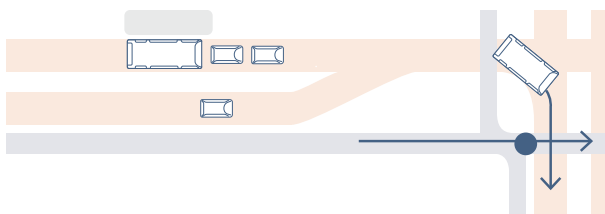

Street Types

Streets and highways today reflect a century of investment in auto-oriented infrastructure that has failed to provide reliable or safe urban mobility. Much more efficient, humane streets are possible. Technological changes present a chance to remake our streets as cities adapt to, and shape, the new mobility system. The changes shown in the following pages are not dependent on vehicle automation. They complement and build upon the new dynamics of mobility, operational safety, and efficient use of space.

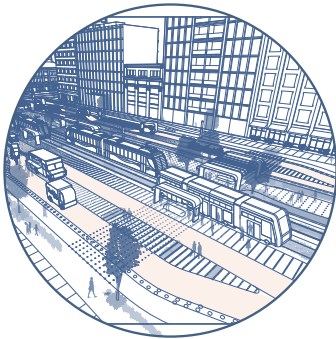

Multiway Boulevard



Major Transit Street

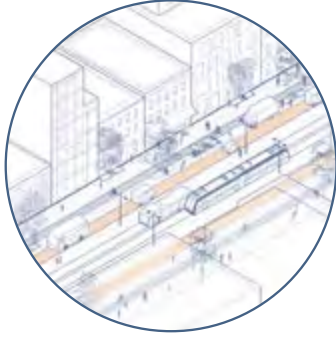

Downtown Street



Section 3:

Design for the Autonomous Age

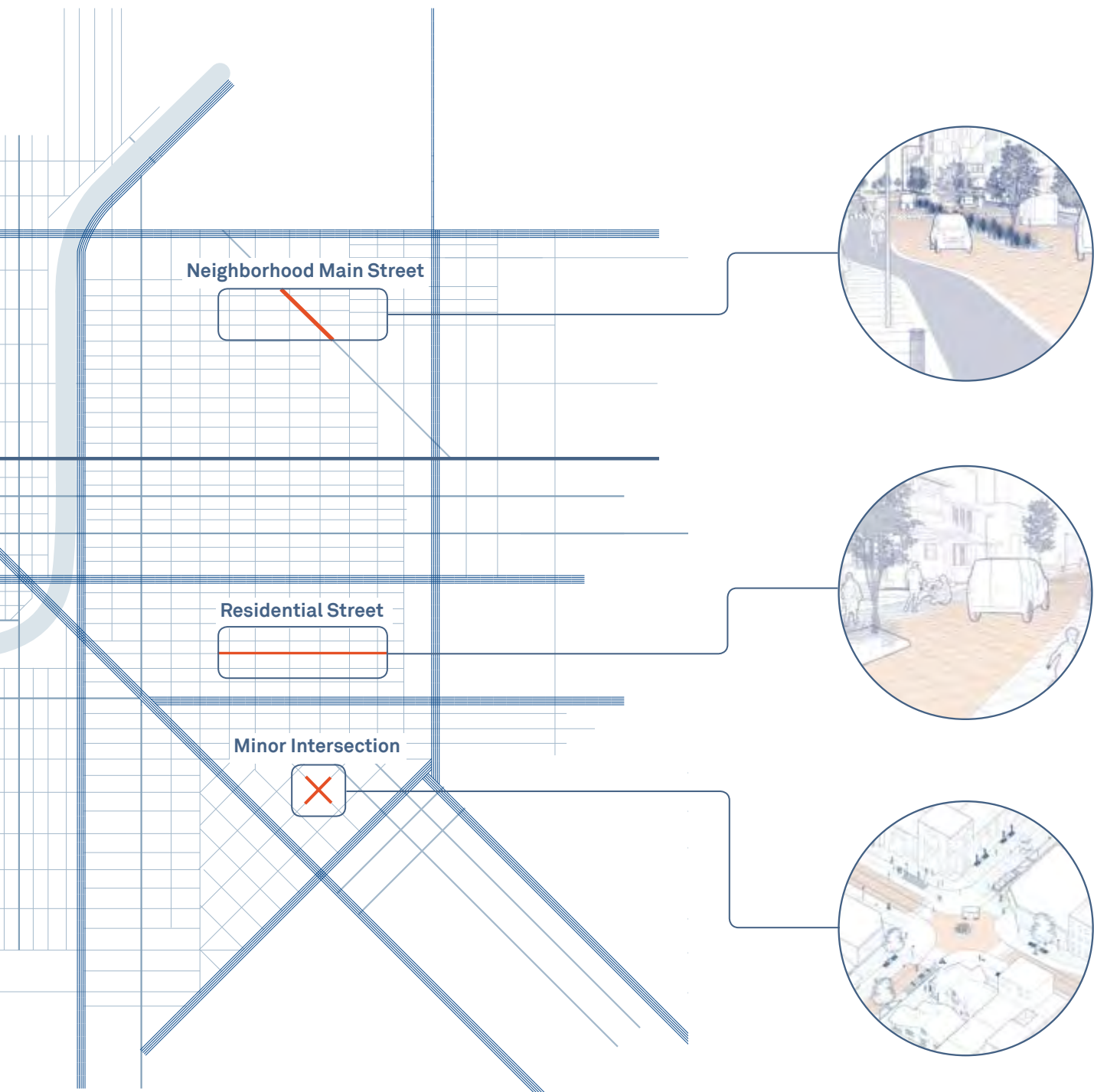

Multiway Boulevard

Multiway boulevards represent an opportunity to reconnect neighborhoods and provide reliable transit. With only one lane for through traffic in each direction, these boulevards could recover a large amount of space for functional green infrastructure such as rain gardens. Managed curbsides can allow for seamless transit access, while dynamic pricing would discourage vehicles from blocking through traffic. By dividing the street into manageable parts and creating more opportunities for people to cross the street, boulevards can link, rather than sever neighborhoods.

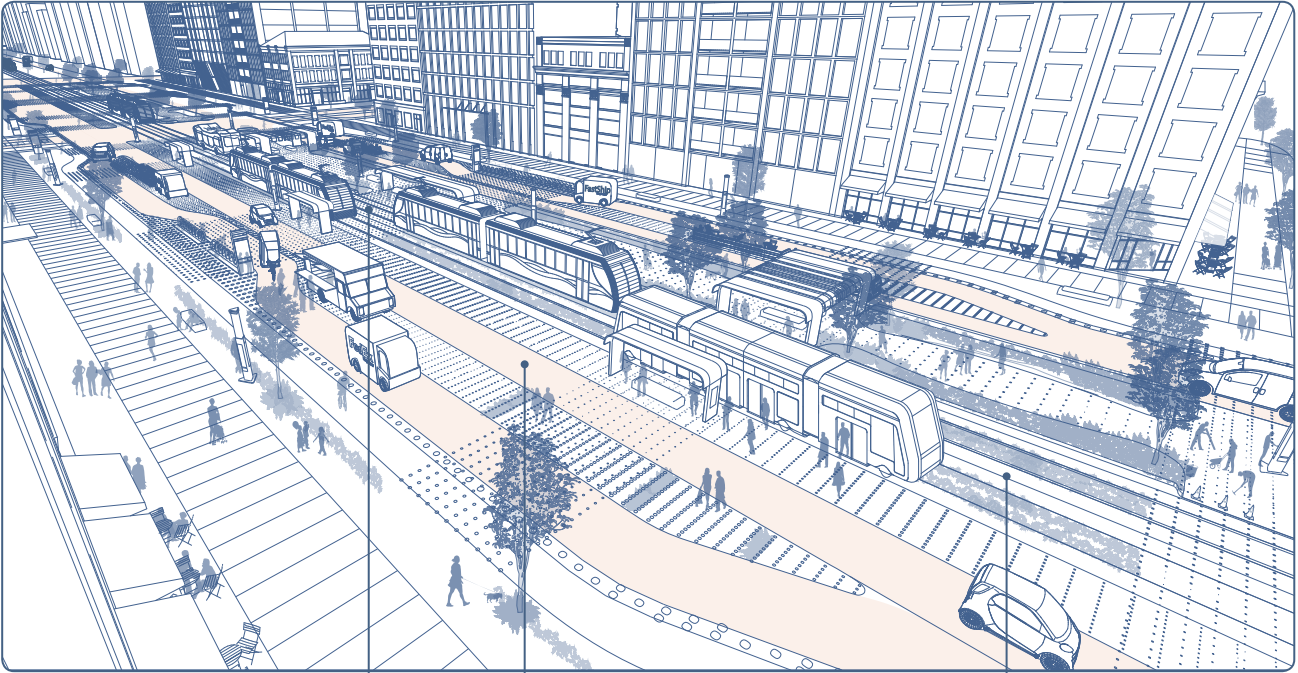

Center Transitway

A transitway in the center lanes afford a priority space for transit unimpeded by other vehicles.

Access Lanes

Access lanes provide space for pick-ups, drop-offs, and deliveries. As pedestrian-priority space, the lanes are fully traversable and could have restricted access at certain times of day.

Green Infrastructure

Green infrastructure helps absorb stormwater and keep the city cool, in addition to providing green space for people to enjoy.

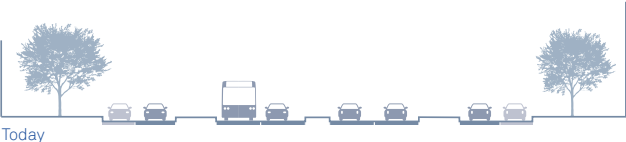

Major Transit Street

Major transit streets serve as critical aggregators in the transportation network, funneling people and activity onto central corridors. To prevent these corridors from turning into impassable robo-routes, cities must use street design to prioritize transit, walking, and biking. With strong design and management, streets that are overburdened by car traffic today can become welcoming, high-performing public spaces in the future.

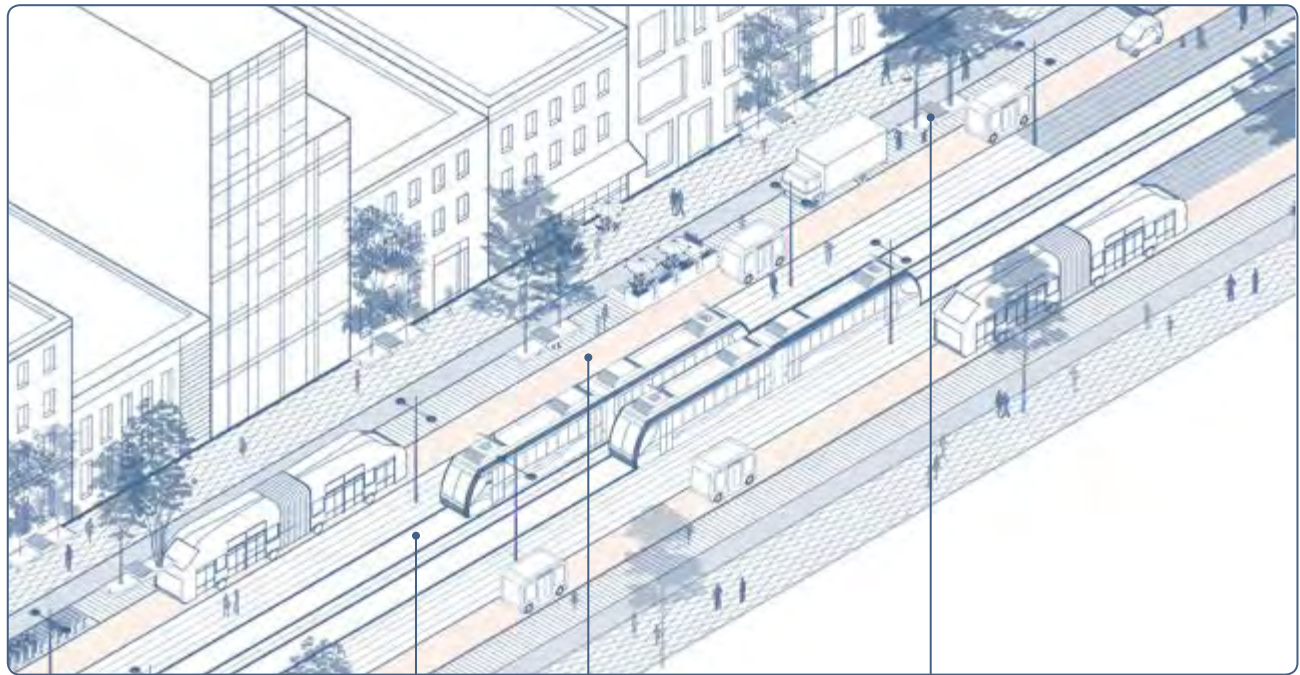

Dedicated Transit Lanes

Dedicated, central lanes serve bus and light rail while smaller vehicles could be permitted in narrow access lanes.

Mobility Hubs

Trunkline transit integrates seamlessly with point-to-point options. Cities' proactive policies on data sharing allow for integrated transit options, no matter the provider.

The Flex Zone

Freight and small vehicles access the flex zone at low speeds. Dynamic pricing and management allows the former curbside to alternate between public space, loading/unloading, and pick-up/drop-off.

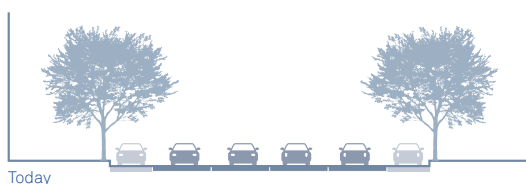

Downtown Street

Downtown streets, perennially in high demand by many modes and as gathering spaces, are vital to the future of the city. Every element of the street, from sidewalks to loading zones, should allow a seamless walking experience for people, and high-capacity transit should be given the space it needs to operate reliably. Cities should prioritize transit and freight access by enacting pricing policies that disincentivize single/low-occupancy vehicles.

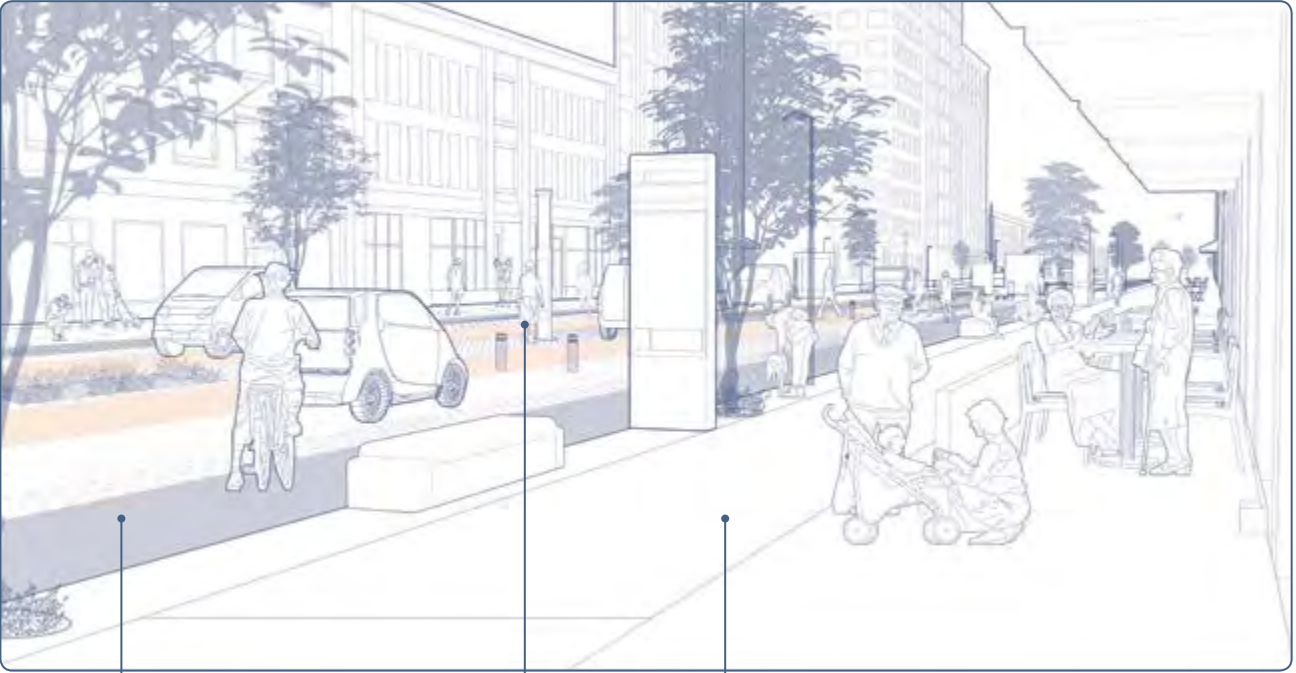

Protected Bike Lanes

With motor vehicles still present, people bicycling will need protection from traffic in the form of fully separate infrastructure buffered from flex zones.

Safe & Short Crossings

Crossing the street is no longer a difficult or time consuming task. Traffic streams of few cars with frequent breaks and smaller lanes allow safer crossing environments.

Parking to Public Spaces

The rebalanced right-of-way allows for lively public spaces, leaving enough room for sidewalk cafes and expansive sidewalk areas. No vehicles would need to be stored on downtown streets.



Today



Tomorrow

Neighborhood Main Street

Neighborhood main streets are active, lively places that attract people from across the area. They are also where residents pick up mobility services such as transit and bikeshare. Accessible mobility hubs can facilitate better corner-to-corner transit services, and dedicated bicycle infrastructure would prioritize non-auto modes.



Freight and Loading

Small freight vehicles use the curb lane. Their small size allows them to load/unload quickly and efficiently without endangering pedestrians or cyclists.

Surfaces Over Striping

With vehicle speeds at a bicycle pace, bicyclists and vehicles interact seamlessly by using separated but flush lanes. Street surfaces indicate the rules of the road in place of striping.

Functional Medians

Permeable medians manage stormwater and beautify neighborhoods while also providing a refuge for pedestrians crossing the street.



Residential Street

Residential streets are the heart of the city. As improved transit and shared AV and micromobility services decrease the need for vehicle storage, streets can become new public spaces and front yards. Flush curbs create environments that are fully accessible and green infrastructure further beautifies the streets. Shared residential streets become central meeting hubs for the community and encourage transit travel through bike share and nearby mobility hubs for corner-to-corner transportation options.

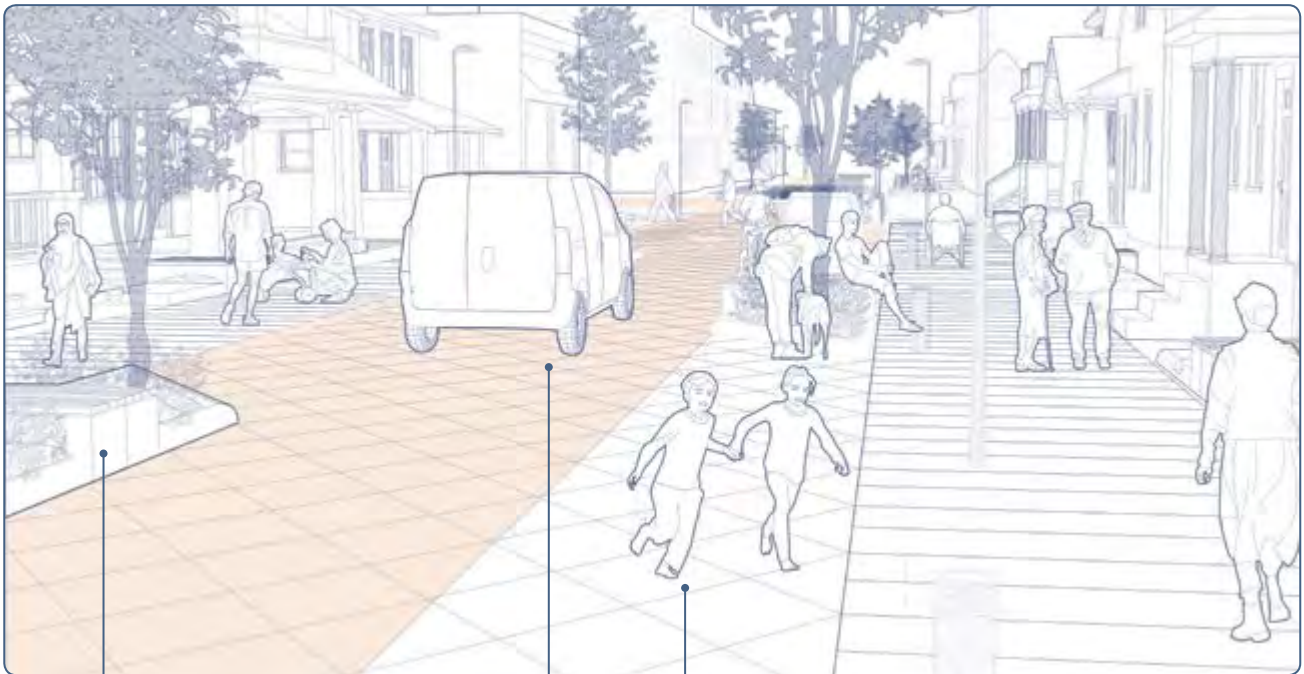

Green Infrastructure

Trees, bioswales, and planters reduce stormwater runoff, while providing shade and evaporative cooling effect for the neighborhood.

Vehicle Access

Most vehicles are restricted, permitting only local traffic and deliveries. Speeds are limited to 10 mph.

Play Streets

Residential streets are primarily spaces for residents to enjoy—for people to recreate or meet neighbors.



Minor Intersection

Minor Intersections serve as the core of residential neighborhoods, with dynamic mobility hubs, shared micromobility, car share and other mobility services. Mini-roundabouts, diverters, and flush curbs can communicate the residential, shared nature of the street, while active volume and speed management would ensure that these areas are protected from through traffic.

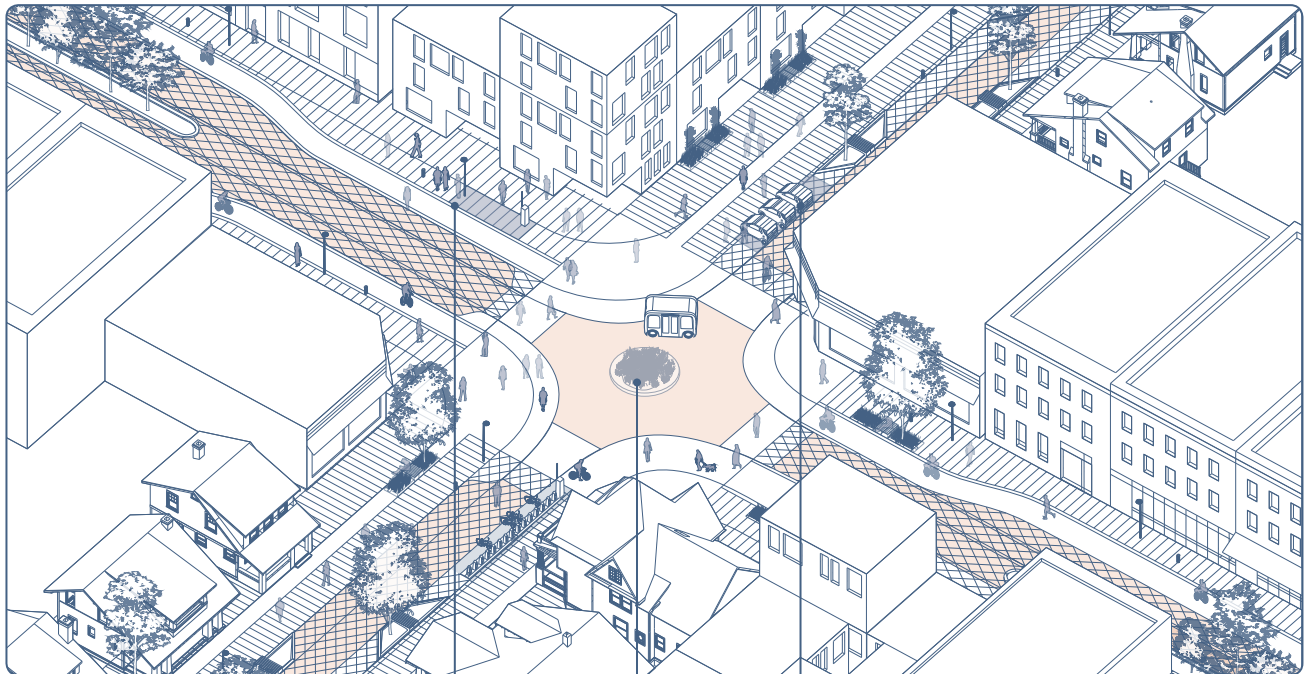

Mobility Hubs

Mobility hubs provide clearly marked zones for pick-up and drop-off, necessary for the corner-to-corner transportation services in the new mobility network.

Mini-Roundabouts

Pedestrian delay is significantly decreased thanks to shorter crossing distances. Mini-roundabouts allow vehicles to travel at consistent, slow speeds.

Last Mile Connections

Local transit and shared micromobility options are abundant in residential neighborhoods, allowing multiple options to connect to core transit close by.



Photo: Seattle DOT (Seattle)



3.2

Curbs for Access

Zones of the Future Street.....	118
The Flex Zone.....	119
Coding the Curb.....	120

3.2

Curbs for Access

Historically, most cities have managed their curbsides based on adjacent land use and historic precedent. In practice, this often means that the most desirable curbsides, for example along a main shopping street, are priced the same as all other curbs, even when behavioral science and economics shows that they should be priced at the highest rates and in the shortest increments to encourage turnover and allow for as many shoppers as possible. Compounding this challenge, in most cities, curbside regulations are static, based on time limits, uses, or residency, which leaves cities unable to adjust prices by time of day or in response to demand.

But already, the curb is changing. In many cities, today's curb is activated by a diversity of new uses, including bike share, car share, freight loading, food trucks, bioswales, pedestrian safety bulb-outs, ride-hail, delivery trucks, and other competing uses. If people switch to transit and shared services in large numbers, residential and commercial parking pressures could diminish. A flexible, adaptable program of amenities, ranging from permanent public spaces like parklets to temporary programs like food trucks or small vendors, could be programmed in the freed up curb space.

Today and in the future, managing the curb will be essential. Emerging technologies can help cities dynamically shape and manage curbs as flexible, or “flex,” zones serve different uses and users at different times. Enhanced with sensors, the price and allowed use for the most in-demand curb space could fluctuate according to the time of day or shifting public priorities. Real-time curbside management systems could allow vehicles to automatically reserve time slots a few minutes in advance of arrival at a site. Armed with sufficient data, cities could actively manage curbsides, setting rates in real-time, changing uses with demand, and automating enforcement to ensure turnover.

Cities don't need to wait for fully autonomous vehicles in order to take advantage of new and emerging technologies. Technological advances are driving down the cost and size of sensor technologies. Cities are repurposing static parking meters to enable dynamic pricing tools. Cities should expand on these investments by inventorying curbside uses and regulations, building smart partnerships with the private sector, and using new technologies like LIDAR to collect data.

Who Gets Curbside Priority?

As curbside demand intensifies, cities must develop curbside prioritization and management frameworks that spell out how to make decisions about user priority, including decisions that balance expected revenues with public benefits.



1

Buses, Transit, & Bikes

Cities should prioritize curbside uses and modes that serve the most people in the most sustainable fashion. Buses, para-transit, and other surface transit, which are the most efficient way to move people, come first. Active modes which feed transit and are the most sustainable and require minimal space, are also high priority.

2

Freight & Delivery

Second, cities should focus on the curbside needs for freight and delivery, which are necessary to sustain local economies, and on green spaces for people to relax, congregate, and shop.

3

Individual Trip Vehicles

Lastly, only after other needs are served, cities should allocate space to individual trip vehicles, whether shared, fleet, or personal, and ride-hail services.

Zones of the Future Street



The Flex Zone

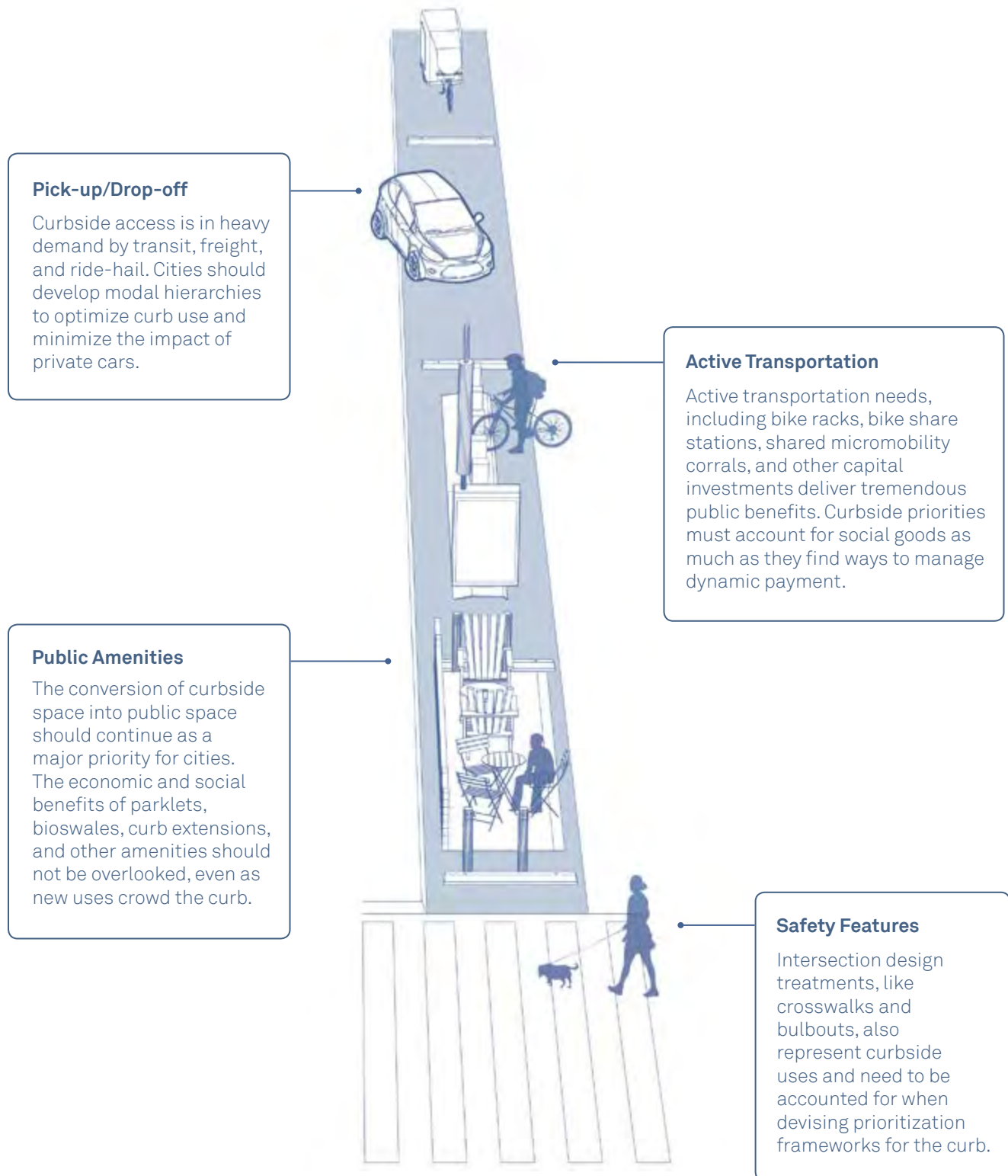

Coding the Curb

As cities update curbside regulations and shift to demand-based management systems, they must ensure that this information is coded in formats that are standardized, open, and available to street users. In particular, a strategic flow of data about how curbside assets are used can help cities understand demand throughout the day and prioritize modes and uses accordingly. Already, new data sharing pilots are focusing on curbside management pilots as a testbed for public-private collaborations.

Cities should begin by inventorying curbside uses and regulations, and using new technologies like LIDAR to collect and automate data. Owning and managing curbside asset data is the number one way that cities can assume control over the future of the curb, especially as private sector actors begin to catalog curbside data for their own traffic management.

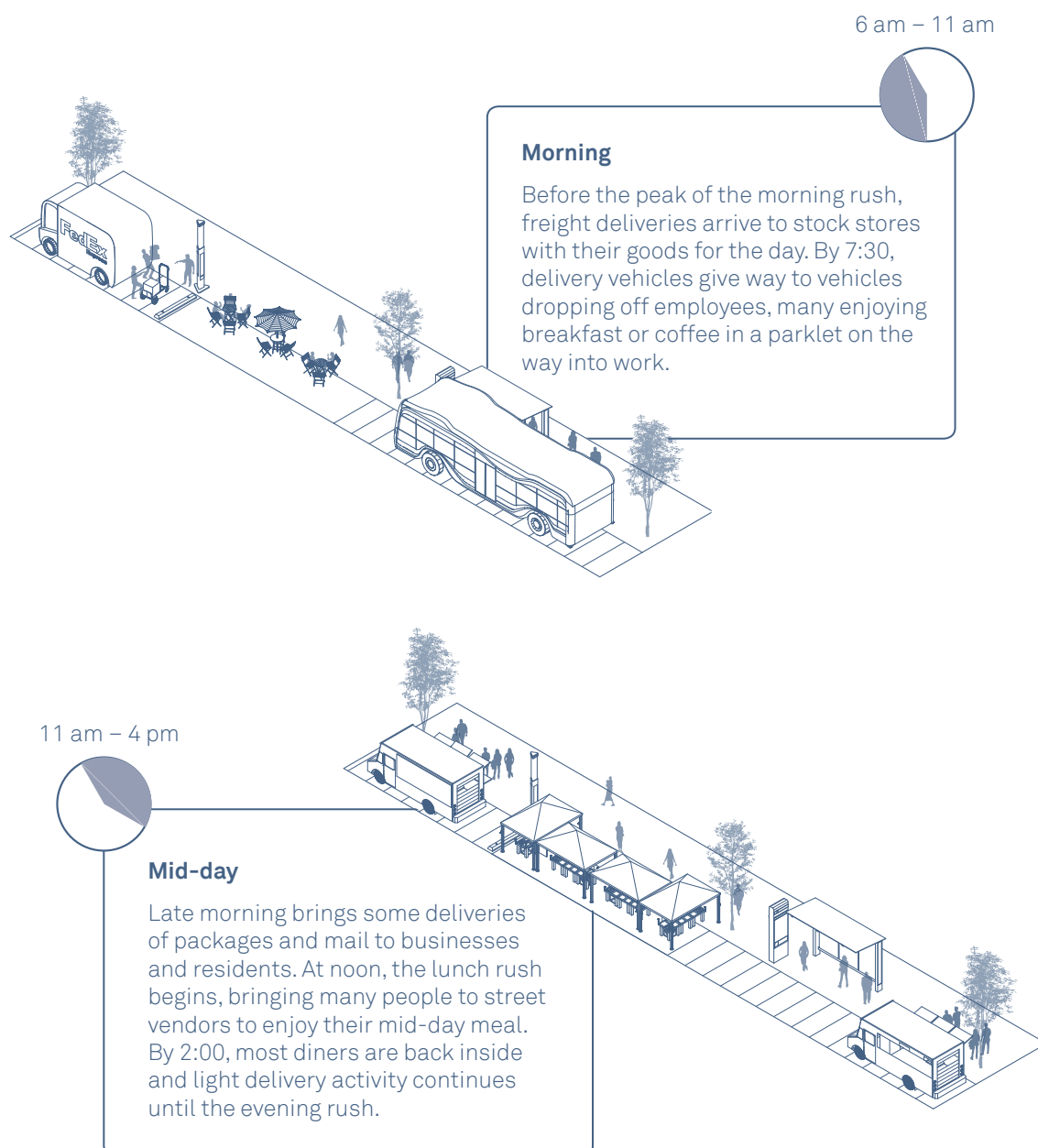

Section 3:

Design for the Autonomous Age

4 pm – 12 am

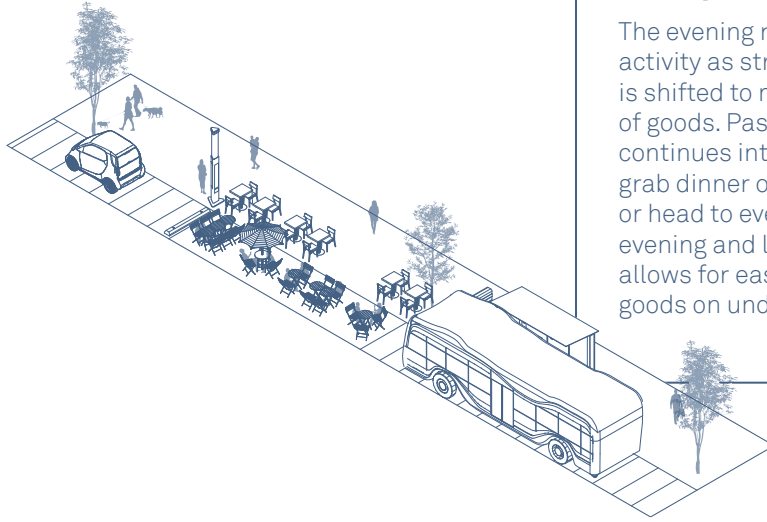

Evening

The evening rush stops delivery activity as street and vehicle capacity is shifted to move people instead of goods. Passenger movement continues into the evening as people grab dinner or drinks, pick up children, or head to evening events. Automated evening and late-night delivery activity allows for easy movement of large goods on underutilized streets.

12 am – 6 am



Late night

Late at night the curb prioritizes freight vehicles. Passenger movement is at a minimum through the early hours of the morning, leaving more space for increased delivery services in cities. Delivery ease is increased through the use of nearby storage lockers. In the morning, freight makes way for transit vehicles.

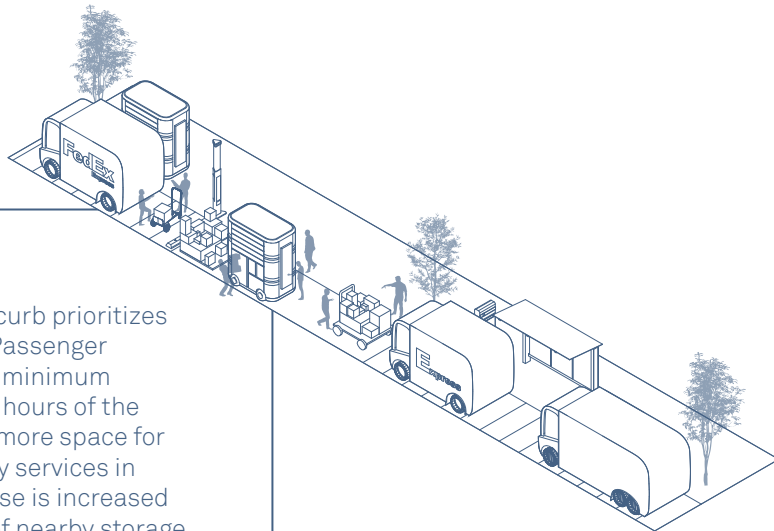

Section 4:

Resources

Endnotes

- 1 Schaller, Bruce (2018). The New Automobility. Retrieved from: <http://www.schallerconsult.com/rideservices/automobility.htm>.
- 2 Schaller, Bruce (2018). The New Automobility. Retrieved from: <http://www.schallerconsult.com/rideservices/automobility.htm>, p. 2.
- 3 Bierstedt, Jane (2014). Effects of Next Generation Vehicles on Travel Demand and Highway Capacity. Retrieved from https://orfe.princeton.edu/~alaink/Papers/FP_NextGenVehicleWhitePaper012414.pdf.
- 4 Uber Elevate (n.d.). Aerial ridesharing at scale. Retrieved from: <https://www.uber.com/us/en/elevate/uberair/>.
- 5 Volvo S90 Owner's Manual. Retrieved from: <https://carmanuals2.com/get/volvo-s90-2019-owner-s-manual-112198>.
- 6 Society of Automotive Engineers Internations. (2018, June 15). Taxonomy and Definitions for Terms Related to Driving Automation Systems for On-Road Motor Vehicles. Retrieved from: https://www.sae.org/standards/content/j3016_201806/.
- 7 Körber, Moritz, Cingel, Andrea, Zimmermann, Markus, Bengler, Klaus. 2015. Vigilance decrement and passive fatigue caused by monotony in automated driving. *Procedia Manufacturing* 3: 2403–9.
- 8 Gregg, T and Wakabayashi, D (2018, March 21). How a self-driving Uber killed a pedestrian in Arizona. *The New York Times*. Retrieved from: <https://www.nytimes.com/interactive/2018/03/20/us/self-driving-uber-pedestrian-killed>.
- 9 Toyota Camry Drivers Manual. Retrieved from: <https://www.toyota.com/t3Portal/document/om-s/OM06122U/pdf/OM06122U.pdf>, pp. 242-251.
- 10 Beene, R (2019, February 13). NHTSA's autopilot claim that Tesla touted disputed in new study. *Bloomberg*. Retrieved from: <https://www.bloomberg.com/news/articles/2019-02-13/nhtsa-s-autopilot-claim-that-tesla-touted-disputed-in-new-study>.
- 11 Voegelé, T and Zhivov, N (2016). Cooperative Mobility Systems and Automated Driving. Retrieved from: <https://www.itf-oecd.org/sites/default/files/docs/cooperative-mobility-systems-automated-driving-roundtable-summary.pdf>.
- 12 US Department of Transportation (2019). Automated Vehicles 3.0: Preparing for the Future of Transportation. Retrieved from: <https://www.transportation.gov/av/3>.
- 13 SELF DRIVE Act, H.R. 3388, 115th Congress. (2017).
- 14 US Department of Transportation (2019). Automated Vehicles 3.0: Preparing for the Future of Transportation. Retrieved from: <https://www.transportation.gov/av/3>, p. 23.
- 15 US Department of Transportation (2017). Automated Vehicles 2.0: A Vision for Safety. Retrieved from: https://www.nhtsa.gov/sites/nhtsa.dot.gov/files/documents/13069a-ads2.0_090617_v9a_tag.pdf, p. 16.
- 16 US Department of Transportation (2019). Automated Vehicles 3.0: Preparing for the Future of Transportation. Retrieved from: <https://www.transportation.gov/av/3>, p. 13.
- 17 US Department of Transportation (2019). Automated Vehicles 3.0: Preparing for the Future of Transportation. Retrieved from: <https://www.transportation.gov/av/3>, p. 20.
- 18 AV START Act, S. 1885, 115th Congress. (2017-2018).
- 19 Smith, R, Borkholder, J, Montgomery, M, Chen, M S. Uber State Interference: How TNCs Buy, Bully, and Bamboozle Their Way to Deregulation. Retrieved from: <https://www.nelp.org/publication/uber-state-interference/>.
- 20 Vock, D (2018, February 18). The Bike-Share Company Trying to Bypass Cities. *Governing*. Retrieved from: <https://www.governing.com/topics/transportation-infrastructure/gov-dockless-bike-preemption-ofto-florida.html>.
- 21 Cohen, J (2018, February 13). A New State Preemption Battlefield: Dockless Bikesharing. *Citylab*. Retrieved from: <https://www.citylab.com/transportation/2018/02/florida-state-preemption-dockless-bikesharing/553235/>.
- 22 Descant, S (2019, July 2). California, Other States Take on E-Scooter Regulations. *Government Technology*. Retrieved from: <https://www.govtech.com/transportation/California-Other-States-Take-on-E-Scooter-Regulations.html>.
- 23 State of California Department of Motor Vehicles (2018, April 2). Driverless testing of autonomous vehicles. Retrieved from: <https://www.dmv.ca.gov/portal/dmv/detail/vr/autonomous/auto>.

Section 4:

Resources

- 24 Phillips, E. (2018). The future of autonomous vehicles in American cities. *NYU Journal of Legislation and Public Policy*, 21(1). Retrieved from: <http://www.nyuylpp.org/wp-content/uploads/2018/06/Legis-21-1-Note-Phillips-FutureAutonomousVehicle.pdf>, p. 306.
- 25 American Public Transportation Association (2019, April). *Public Transportation Fact Book*. Retrieved from: https://www.apta.com/wp-content/uploads/APTA_Fact-Book-2019_FINAL.pdf, p. 12.
- 26 TransitCenter (2019, February). *Who's on Board 2019: How to Win Back America's Transit Riders*. Retrieved from: <https://transitcenter.org/publication/whos-on-board-2019/>.
- 27 New York City Department of Transportation (2014, August). *SelectBusService Bx41 on Webster Avenue Progress*. Retrieved from: <http://web.mta.info/mta/planning/sbs/docs/WebsterAveSBS-ProgressReport-2014.pdf>, p. 18.
- 28 Toronto Transit Commission (2019, April 2). *The Future of King Street: Results of the Transit Pilot*. Retrieved from: <https://www.toronto.ca/legdocs/mmis/2019/ex/bgrd/backgroundfile-131188.pdf>.
- 29 Transportation Trades Department, AFL-CIO (2019, March 2). *Principles for the Transit Workforce in Automated Vehicle Legislation and Regulations*. Retrieved from: <https://ttd.org/policy/principles-for-the-transit-workforce-in-automated-vehicle-legislation-and-regulations/>.
- 30 Hughes-Cromwick, M. (2018). *APTA 2018 Public Transportation Fact Book*. Retrieved from: <http://www.apta.com/wp-content/uploads/Resources/resources/statistics/Documents/FactBook/2018-APTA-Fact-Book.pdf>.
- 31 Kaufman, S. M, Smith, A, O'Connell, J., Marulli, D. *Intelligent Paratransit*. Retrieved from: https://wagner.nyu.edu/files/rudincenter/2016/09/INTELLIGENT_PARATRANSIT.pdf.
- 32 Westervelt, M et al. (2018) *UpRouted: Exploring Microtransit in the United States*. Retrieved from: <https://www.enotrans.org/wp-content/uploads/2018/01/UpRouted-18.pdf>.
- 33 Urgo, J. (2018, May 5). *Flex V. Fixed: An Experiment in On-Demand Transit* [Web log message]. Retrieved from: <https://transitcenter.org/adding-flexible-routes-improve-fixed-route-network/>.
- 34 Flores Dewey, O. (2016) *How Mexico City is Transforming a Jitney System into a World Class Bus Rapid Transit System*. Retrieved from Publisher website: <http://www.transformingurbantransport.com/>.
- 35 TransLink (2018). *2018 Transit Service Performance Review: SkyTrain and West Coast Express Summaries*. Retrieved from: <https://public.tableau.com/profile/translink#!/vizhome/2018TSPR-RailSummaries/TableofContents>.
- 36 TransLink (2019). *SkyTrain Schedules*. Retrieved from: <https://www.translink.ca/Schedules-and-Maps/SkyTrain/SkyTrain-Schedules.aspx>.
- 37 TransLink (2018). *2018 Transit Service Performance Review: SkyTrain and West Coast Express Summaries*. Retrieved from: <https://public.tableau.com/profile/translink#!/vizhome/2018TSPR-RailSummaries/TableofContents>.
- 38 TransLink (2018). *2018 Transit Service Performance Review*. Retrieved from: https://www.translink.ca/-/media/Documents/plans_and_projects/managing_the_transit_network/2018-TSPR/2018-Transit-Service-Performance-Review.pdf, p. 6.
- 39 A. Devlin, email communication, June 13, 2019.
- 40 Christof Speiler (2015). *Reimagining the Bus* [pdf]. Retrieved from https://nacto.org/wp-content/uploads/2015/07/Christof-Spieler-Morris-Architects_Reimagining-the-Bus.pdf.
- 41 US Federal Highway Administration (2017, February 21). "3.2 Trillion Miles Driven On U.S. Roads In 2016: New Federal Data Show Drivers Set Historic New Record." Retrieved from: <https://www.fhwa.dot.gov/pressroom/fhwa1704.cfm>.
- 42 INRIX (2018). "INRIX Global Traffic Scorecard." Retrieved from: <http://inrix.com/scorecard/>.
- 43 U.S. Environmental Protection Agency (2017). "Sources of Greenhouse Gas Emissions." Retrieved from: <https://www.epa.gov/ghgemissions/sources-greenhouse-gas-emissions>.
- 44 M. Taiebat, S. Stolper, M. Xu. (2019). Forecasting the impact of connected and automated vehicles on energy use: a microeconomic study of induced travel and energy rebound. *Appl Energy*, 247 (2019), pp. 297-308, DOI: 10.1016/j.apenergy.2019.03.174.

- 45 Schaller, Bruce (2018). The New Automobility. Retrieved from: <http://www.schallerconsult.com/rideservices/automobility.htm>.
- 46 Tri-State Transportation Campaign (2018, January 4). Road Pricing in London, Stockholm, and Singapore. Retrieved from: http://nyc.streetsblog.org/wp-content/uploads/2018/01/TSTC_A_Way_Forward_CPreport_1.4.18_medium.pdf.
- 47 Tri-State Transportation Campaign (2018, January 4). Road Pricing in London, Stockholm, and Singapore. Retrieved from: http://nyc.streetsblog.org/wp-content/uploads/2018/01/TSTC_A_Way_Forward_CPreport_1.4.18_medium.pdf.
- 48 Börjesson, M., Eliasson, J., Hugosson, M. B., & Brundell Freij, K. (2012). The Stockholm congestion charges—5 years on. Effects, acceptability and lessons learnt. *Transport Policy*, 20(1–12).
- 49 Schaller, Bruce (2017). Making Congestion Pricing Work for Traffic and Transit in New York City. Retrieved from: <http://schallerconsult.com/rideservices/makingpricingwork.pdf>, p. 8.
- 50 Schaller, Bruce (2017). Making Congestion Pricing Work for Traffic and Transit in New York City. Retrieved from: <http://schallerconsult.com/rideservices/makingpricingwork.pdf>, p. 1.
- 51 Tri-State Transportation Campaign (2018, January 4). Road Pricing in London, Stockholm, and Singapore. Retrieved from: http://nyc.streetsblog.org/wp-content/uploads/2018/01/TSTC_A_Way_Forward_CPreport_1.4.18_medium.pdf, p. 10.
- 52 Hedgpeth, D. (2018, September 5). Toll hits \$46.75 on I-66 lanes inside the Beltway. *Washington Post*. Retrieved from: <https://www.washingtonpost.com/transportation/2018/09/05/toll-hits-i-lanes-inside-beltway/>.
- 53 Team London Bridge (n.d.). Bikes for Business. Retrieved from: <https://www.teamlondonbridge.co.uk/bikesforbusiness>.
- 54 U.S. Federal Highway Administration (2017). Income-Based Equity Impacts of Congestion Pricing—A Primer. Retrieved from: https://ops.fhwa.dot.gov/publications/fhwahop08040/cp_prim5_03.htm.
- 55 Tri-State Transportation Campaign (2018, January 4). Road Pricing in London, Stockholm, and Singapore. Retrieved from: http://nyc.streetsblog.org/wp-content/uploads/2018/01/TSTC_A_Way_Forward_CPreport_1.4.18_medium.pdf, p. 6.
- 56 Transport for London (2019). Pay as you go caps. Retrieved from: <https://tfl.gov.uk/fares/find-fares/tube-and-rail-fares/pay-as-you-go-caps>.
- 57 Schaller, Bruce (2018). Empty Seats, Full Streets. Retrieved from: <http://schallerconsult.com/rideservices/emptyseatsfullstreets.pdf>, p. 8.
- 58 Seattle Department of Transportation. (2019, May 23). Let's talk about managing Seattle's congestion in a fair and equitable way. [Blog post]. Retrieved from <http://www.seattle.gov/transportation/getting-around/driving-and-parking/congestion-pricing>.
- 59 District Department of Transportation (January 2019). ParkDC Penn Quarter/Chinatown Parking Pricing Pilot: Final Results. Retrieved from: https://ddot.dc.gov/sites/default/files/dc/sites/ddot/page_content/attachments/parkDC%20-%20Executive%20Summary_Final_20190109.pdf.
- 60 Tri-State Transportation Campaign (2018, January 4). Road Pricing in London, Stockholm, and Singapore. Retrieved from: http://nyc.streetsblog.org/wp-content/uploads/2018/01/TSTC_A_Way_Forward_CPreport_1.4.18_medium.pdf.
- 61 Krzanich, B. (2017, December 20). Brian Krzanich, CEO, Intel - Driven by Data - AutoMobility LA [video file]. Retrieved from: <https://www.youtube.com/watch?v=EskMldJrJdk>.
- 62 de Montjoye, Y.-A., Hidalgo, C. A., Verleysen, M., & Blondel, V. D. (2013). Unique in the Crowd: The privacy bounds of human mobility. *Scientific Reports*, 3, 1376. Retrieved from: <https://doi.org/10.1038/srep01376>.
- 63 Atockar (2014, September 15). Riding With The Stars: Passenger Privacy in the NYC Taxicab Dataset. Retrieved from: <https://research.neustar.biz/author/atockar/>.
- 64 Stewart, E (2018, December 21). Facebook scandals, 2018. *Vox*. Retrieved from: <https://www.vox.com/technology/2018/12/21/18149099/delete-facebook-scandals-2018-cambridge-analytica>.
- 65 MacMillan, D and MacMillan, R (2018, October 8). Google Exposed User Data, Feared Repercussions of Disclosing to Public. *Wall Street Journal*. Retrieved from: <https://www.wsj.com/articles/google-exposed-user-data-feared-repercussions-of-disclosing-to-public-1539017194>.
- 66 Melley, B (2019, January 8). Weather Channel app accused of selling users' personal data. *Seattle Times*. Retrieved from: <https://www.seattletimes.com/business/la-sues-weather-channel-alleging-it-sold-app-users-data/>.

Section 4:

Resources

67 Laseter, T (2018, July 30). The Rise of the Last-Mile Exchange. Strategy+Business. Retrieved from: <https://www.strategy-business.com/article/The-Rise-of-the-Last-Mile-Exchange?gko=d0a62>.

68 American Transportation Research Institute (2018, October). Cost of Congestion to the Trucking Industry: 2018 Update. Retrieved from: <https://atri-online.org/wp-content/uploads/2018/10/ATRI-Cost-of-Congestion-to-the-Trucking-Industry-2018-Update-10-2018.pdf> p. 6.

69 Ploos van Amstel, W., Balm, S., Warmerdam, J., Boerema, M., Altenburg, M., Rieck, F., & Peters, T. (2018). City logistics: light and electric: LEFV-LOGIC: research on light electric freight vehicles. (Publications by Amsterdam University of Applied Sciences Faculty of Technology; No. 13). Amsterdam: Hogeschool van Amsterdam.

70 Christian, A. W., & Cabell, R. (2017). Initial Investigation into the Psychoacoustic Properties of Small Unmanned Aerial System Noise. In 23rd AIAA/CEAS Aeroacoustics Conference. American Institute of Aeronautics and Astronautics. <https://doi.org/doi:10.2514/6.2017-4051>.

71 US Department of Transportation, Bureau of Transportation Statistics (2018). Transportation Economic Trends 2018. Retrieved from: <https://www.bts.gov/transportation-economic-trends/tet-2018-chapter-4-employment>.

72 Volvo Vera. Retrieved from: <https://www.volvotrucks.com/en-en/about-us/automation/vera.html>.

73 Reid, C (2019, May 31). E-Cargobikes Do 30 Daily Drops Compared To 12 By Van, Finds 154-Year-Old London Courier Company. Forbes. Retrieved from: <https://www.forbes.com/sites/carltonreid/2019/05/31/e-cargobikes-do-30-daily-drops-compared-to-12-by-van-finds-154-year-old-london-courier-company/>.

74 Bui, Q (2015, February 5). Map: The Most Common Job In Every State. NPR. Retrieved from: <https://www.npr.org/sections/money/2015/02/05/382664837/map-the-most-common-job-in-every-state>.

75 Center for Global Policy Solutions. (2017). Stick Shift: Autonomous Vehicles, Driving Jobs, and the Future of Work. Washington, DC: Center for Global Policy Solutions.

76 Chiarenza, Jonah, Margo Dawes, Alexander K. Epstein, PhD, Donald Fisher, PhD, and Katherine Welty (2018). Optimizing Large Vehicles for Urban Environments. Retrieved from: https://nacto.org/wp-content/uploads/2018/12/NACTO-Volpe-Optimizing-Large-Vehicles_ADAS.pdf.

77 Paine, G (2019, May 3). Drones to deliver incessant buzzing noise, and packages. The Conversation. Retrieved from: <https://theconversation.com/drones-to-deliver-incessant-buzzing-noise-and-packages-116257>.

78 Center for Disease Control and Prevention (2016). Vital Signs: Motor Vehicle Injury Prevention — United States and 19 Comparison Countries. Retrieved from: https://www.cdc.gov/mmwr/volumes/65/wr/mm6526e1.htm?s_cid=mm6526e1_w.

79 U.S. Environmental Protection Agency (2017). “Sources of Greenhouse Gas Emissions.” Retrieved from: <https://www.epa.gov/ghgemissions/sources-greenhouse-gas-emissions>.

Resources

General

Borowiec, Christina, Kailey Laidlaw, Sean Nash, Vincent Racine, Oliver Rojas, Sean Turkenicz, and Yvonne Verlinden. (2016). Planning for Autonomous Vehicles: Imagining Future Alternatives. (Studio final report prepared for the City of Toronto). Ryerson University, Toronto, Canada. Retrieved from: http://transformlab.ryerson.ca/wp-content/uploads/2016/12/Ryerson.University.Nov_.2016.Studio.Technical.Report.pdf

Knorr, Aaron/Perkins + Will. Designing for Future Mobility: Developing a Framework for the Livable Future City. Retrieved from: <http://research.perkinswill.com/articles/designing-the-future-of-mobility-developing-a-framework-for-the-livable-future-city/>

New York City Department of Transportation. (2016). Strategic Plan: 2016. New York, NY. Retrieved from: January 9th 2019. <https://www.nycdotplan.nyc/PDF/Strategic-plan-2016.pdf>

San Francisco Public Works. (2017). Vision Zero San Francisco: Two-Year Action Strategy 2017-2018. San Francisco, CA. Retrieved from: https://issuu.com/sfmdta_marketing/docs/vision_zero_action_strategy_final_d?e=1632400/45840967

Schaller, Bruce. (2018). The New Automobility: Lyft, Uber and the Future of American Cities. Retrieved from: <http://www.schallerconsult.com/rideservices/automobility.pdf>

Shoup, Donald, ed. (2017). Parking and the City. New York, NY: Routledge

Skinner, R., and N. Bidwell/WSP Parsons Brinckerhoff. (2016). Making Better Places: Autonomous Vehicles and Future Opportunities. Retrieved from: <http://www.wsp-pb.com/globaln/uk/wsp-pb-farrells-av-whitepaper.pdf>

Sandt, L., and J.M. Owens/Pedestrian and Bicycle Information Center. (2017). Discussion Guide for Automated and Connected Vehicles, Pedestrians, and Bicyclists. Retrieved from: http://www.pedbikeinfo.org/cms/downloads/PBIC_AV_Discussion_Guide.pdf

Understanding AVs

California Department of Motor Vehicles. (2018). Order to Adopt: Title 13, Division 1, Chapter 1. Article 3.7 – Testing of Autonomous Vehicles and Article 3.8 – Deployment of Autonomous Vehicles. Retrieved from: https://www.dmv.ca.gov/portal/wcm/connect/a6ea01e0-072f-4f93-aa6c-e12b844443cc/DriverlessAV_Adopted_Regulatory_Text.pdf?MOD=AJPERES

Isaac, L. (2016). How Local Governments Can Plan for Autonomous Vehicles. Road Vehicle Automation 3, 59–70.

Martinez, L. (2016). Urban Mobility System Upgrade: How Shared Self-Driving Cars Could Change Traffic. Retrieved from the International Transport Forum website: http://www.internationaltransportforum.org/Pub/pdf/15CPB_Self-drivingcars.pdf

National Highway Traffic Safety Administration. (2017). Automated Driving Systems: A Vision for Safety. Retrieved from: https://www.nhtsa.gov/sites/nhtsa.dot.gov/files/documents/13069a-ads2.0_090617_v9a_tag.pdf

National League of Cities. (2017). Autonomous Vehicles: A Policy Preparation Guide. Retrieved from: <https://www.nlc.org/sites/default/files/2017-04/NLC%20AV%20Policy%20Prep%20Guide.pdf>

US Department of Transportation. (2018, October 4). Preparing for the Future of Transportation: Automated Vehicles 3.0. Retrieved from: <https://www.transportation.gov/sites/dot.gov/files/docs/policy-initiatives/automated-vehicles/320711/preparing-future-transportation-automatedvehicle-30.pdf>

Pricing

International Council on Clean Transportation/Pike, Ed. (2010). Congestion Charging: Challenges and Opportunities. Retrieved from: https://www.theicct.org/sites/default/files/publications/congestion_apr10.pdf

Seattle Department of Transportation. (2019, May 23). Let's talk about managing Seattle's congestion in a fair and equitable way. [Blog post]. Retrieved from <http://www.seattle.gov/transportation/getting-around/driving-and-parking/congestion-pricing>

Seattle Department of Transportation. (2019, May). Seattle Congestion Pricing Study. Retrieved from Seattle.gov website: http://www.seattle.gov/Documents/Departments/SDOT/About/SeattleCongestionPricingStudy_SummaryReport_20190520.pdf

Simoni, Michele, Kara Kockelman, Krishna Gurumurthy, and Joschka Bischoff. (2018). Congestion Pricing in a World of Self-Driving Vehicles: An Analysis of Different Strategies in Alternative Future Scenarios." Forthcoming in *Transportation Research Part C: Emerging Technologies*. Retrieved from: <https://arxiv.org/ftp/arxiv/papers/1803/1803.10872.pdf>

Transit

National Academies of Sciences, Engineering, and Medicine. (2015). *Preliminary Strategic Analysis of Next Generation Fare Payment Systems for Public Transportation*. Washington, DC: The National Academies Press.

National Academies of Sciences, Engineering, and Medicine. (2016). *Shared Mobility and the Transformation of Public Transit*. Washington, DC: The National Academies Press. Retrieved from: <https://doi.org/10.17226/23578>

National Association of City Transportation Officials. (2017). *Curb Appeal: Curbside Management Strategies for Improving Transit Reliability*. Retrieved from: <https://nacto.org/tsdg/curb-appeal-whitepaper/>

Toronto Transit Commission. (2017). *Implications of Automated Vehicles for TTC*. Retrieved from Toronto Transit Commission website: https://www.ttc.ca/About_the_TTC/Commission_reports_and_information/Commission_meetings/2017/March_22/Reports/10_Implications_of_Automated_Vehicles_for_TTC.pdf

TransitCenter. (2018). *ROBOT CARS vs. TRANSIT. TransitTools*, volume 8. Retrieved from: <http://transitcenter.org/wp-content/uploads/2018/09/RobotCars.pdf>

WSB and Associates, Inc., and AECOM. (2018, June). *MnDOT Autonomous Bus Pilot Project Testing and Demonstration Summary*. Retrieved from Minnesota Department of Transportation website: <http://www.dot.state.mn.us/research/reports/2019/201904.pdf>

Urban Freight

City of San Francisco. (2019). Section 794 – Autonomous Delivery Devices on Sidewalks – Permit Required. (Public Works Code Article 15). Retrieved from: [http://library.amlegal.com/nxt/gateway.dll/California/publicworks/publicworkscode?f=templates\\$fn=default.htm\\$3.0\\$vid=amlegal:sanfrancisco_ca\\$sync=1](http://library.amlegal.com/nxt/gateway.dll/California/publicworks/publicworkscode?f=templates$fn=default.htm$3.0$vid=amlegal:sanfrancisco_ca$sync=1)

Flachi, Manuela, Svetlana Popova, Lina Konstantinopoulou, Jean-Charles Pandazis, Giacomo Somma, Aristos Halatsis, and Alexander Stathacopoulos. (2016). *Urban Freight and Service Transport in European Cities*. Brussels, Belgium: Nogelog

Flämig H. (2016). *Autonomous Vehicles and Autonomous Driving in Freight Transport. Autonomous Driving*, edited by M. Maurer, J. Gerdes, B. Lenz, and H. Winner. Berlin, DE: Springer

International Transport Forum. (2018) *The Shared-Use City: Managing the Curb*. Retrieved from the International Transport Forum-Corporate Partnership Board Report website: https://www.itf-oecd.org/sites/default/files/docs/Shared-use-city-managing-curb_3.pdf

International Transport Forum. (2017). *Managing the Transition to Driverless Road Freight Transport*. Retrieved from: <https://www.itf-oecd.org/managing-transition-driverless-road-freight-transport>

Mitman, Meghan F., Steve Davis, Ingrid Armet, and Evan Knopf. (2018). *Curbside Management Practitioners Guide*. Retrieved from the Institute of Transportation Engineers website: <https://www.ite.org/pub/?id=C75A6B8B-E210-5EB3-F4A6-A2FDDA8AE4AA>

Nelson/Nygaard Consulting Associates. (2014). *District Department of Transportation Curbside*

Management Study. Retrieved from the District Department of Transportation website: <https://comp.ddot.dc.gov/Documents/District%20Department%20of%20Transportation%20Curbside%20Management%20Study.pdf>

Ranieri, L, S. Digiesi, B. Silvestri, and M. Roccotelli, (2018). *A Review of Last Mile Logistics Innovations in an Externalities Cost Reduction Vision*. *Sustainability* 10, 782

USDOT Volpe Center/Chiarenza, Jonah, Margo Dawes, Alexander K. Epstein, Donald Fisher, and Katherine Welty. (2018). *Optimizing Large Vehicles for Urban Environments: Advanced Driver Assistance Systems and Downsizing*. Retrieved from NACTO website: <https://nacto.org/optimizing-large-vehicles/>

Data

Hasem, Ibrahim A. T., Victor Chang, Nor Badrul Anua, Adewole K. S., Ibrar Yaqoob, and Abdullah Gani. (2016). The Role of Big Data in Smart City. *International Journal of Information Management*, 36, 5

National Academies of Sciences, Engineering, and Medicine. (2015). *Open Data: Challenges and Opportunities for Transit Agencies*. Washington, DC: The National Academies Press. Retrieved from: <https://doi.org/10.17226/22195>.

National Association of City Transportation Officials & International Municipal Lawyers Association. (2019). *Managing Mobility Data*. Retrieved from NACTO website: https://nacto.org/wp-content/uploads/2019/05/NACTO_IMLA_Managing-Mobility-Data.pdf

Valentino-DeVries, Jennifer, Natasha Singer, Michael Keller, and Aaron Korlik. (2018, December 10). *Your Apps Know Where You Were Last Night, and They're Not Keeping it Secret*. *New York Times*. [New York]. Retrieved from: <https://www.nytimes.com/interactive/2018/12/10/business/location-data-privacy-apps.html>

Street Design

Collarte, Natalia. (2012). *The Woonerf Concept: Rethinking a Residential Street in Somerville*. (Master's thesis). Tufts University, Somerville, MA

CROW. (2007). *Design manual for bicycle traffic*. Retrieved from: <https://www.crow.nl/publicaties/design-manual-for-bicycle-traffic>

Ma, Qinglu, Kara Kockelman, and Marc Segal. (2017) *Making The Most Of Curb Spaces In A World Of Shared Autonomous Vehicles: A Case Study Of Austin, Texas*. (Paper presented at the Transportation Research Board Conference). Retrieved from: https://www.cae.utexas.edu/prof/kockelman/public_html/TRB17ReusingCurbParking.Pdf

National Association of City Transportation Officials. (2013). *Urban Street Design Guide*. New York, NY: Island Press

National Association of City Transportation Officials. (2017). *Designing for All Ages & Abilities: Contextual Guidance for High-Comfort Bicycle Facilities*. Retrieved from NACTO website: https://nacto.org/wp-content/uploads/2017/12/NACTO_Designing-for-All-Ages-Abilities.pdf

National Association of City Transportation Officials. (2019). *Don't Give Up At The Intersection: Designing All Ages and Abilities Bicycle Crossings*. Retrieved from NACTO website: https://nacto.org/wp-content/uploads/2019/05/NACTO_Dont-Give-Up-at-the-Intersection.pdf



Photo: City of Toronto



National Association of City Transportation Officials
120 Park Ave, 21st Floor
New York, NY 10017

