

Optimizing Large Vehicles for Urban Environments

Downsizing

Jonah Chiarenza
Margo Dawes
Alexander K Epstein, Ph.D.
Donald Fisher, Ph.D.
Katherine Welty

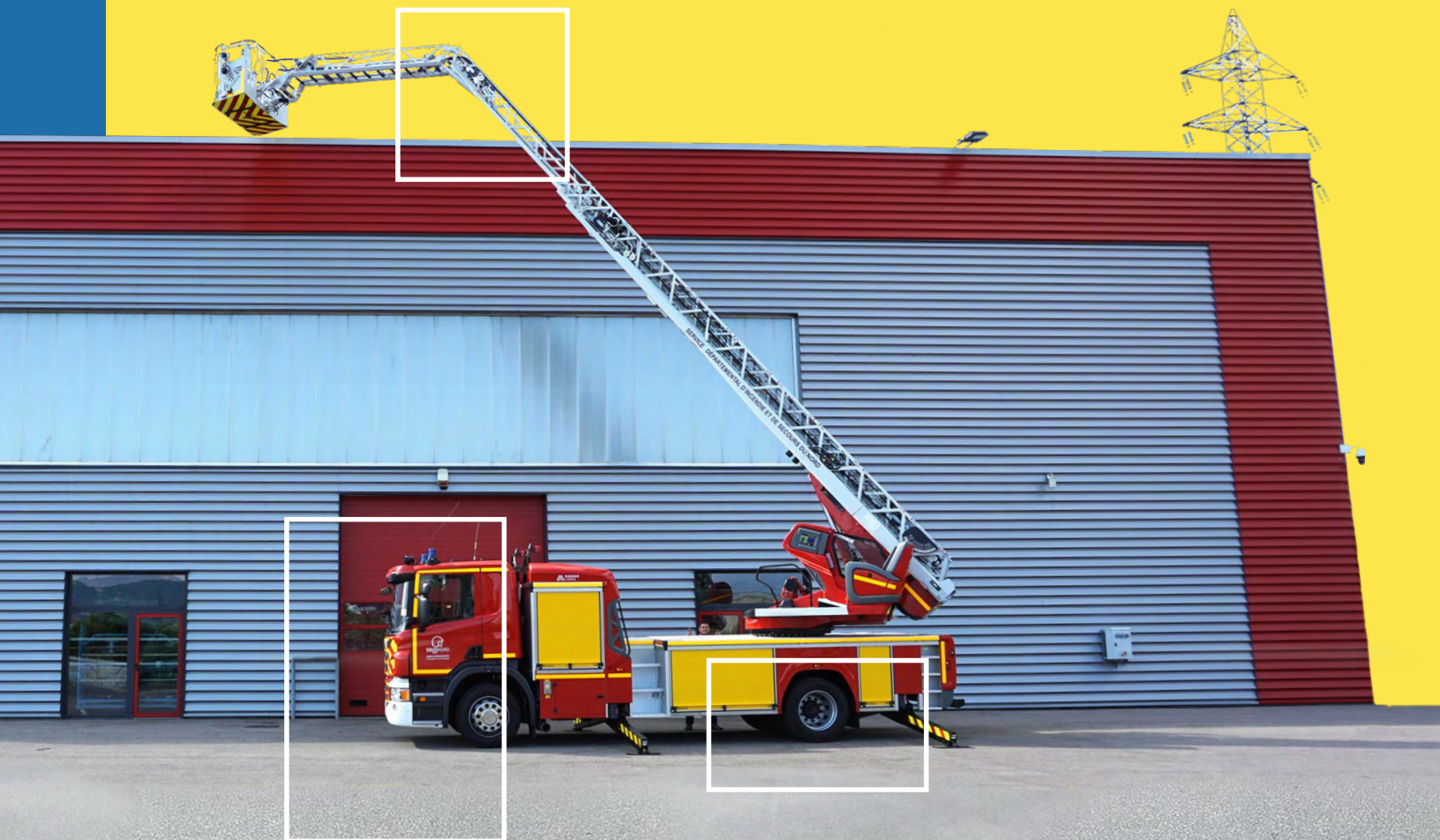

December 2018

DOT-VNTSC-NACTO-18-01

Prepared for:

National Association of City Transportation Officials (NACTO)

New York, New York

U.S. Department of Transportation
John A. Volpe National Transportation Systems Center
55 Broadway
Cambridge, MA 02142-1093

617-494-2000
www.volpe.dot.gov
DOT-VNTSC-NACTO-18-01

Notice

This document is disseminated under the sponsorship of the Department of Transportation in the interest of information exchange. The United States Government assumes no liability for the contents or use thereof.

The United States Government does not endorse products or manufacturers. Trade or manufacturers' names appear herein solely because they are considered essential to the objective of this report.

Acknowledgments

The authors thank Kate Fillin-Yeh of the National Association of City Transportation Officials for sponsoring and supporting this work and thank the Vision Zero Large Vehicle Safety Technology Working Group for valuable input. In particular, the authors acknowledge the cities and representatives whose funding and participation on the Working Group made this effort possible:

- ▶ **Boston** - Kristopher Carter (Boston Mayor's Office of New Urban Mechanics) and Charlotte Fleetwood (Boston Transportation Department)
- ▶ **Chicago** - Mike Amsden, Luann Hamilton, Rosanne Ferruggia Lubeck, David Pertuz, and Sean Wiedel (Chicago Department of Transportation)
- ▶ **Los Angeles** - Richard Coulson and Kris Goolsby (Los Angeles Department of General Services) and Nat Gale (Los Angeles Department of Transportation)
- ▶ **San Francisco** - John Knox White (San Francisco Municipal Transportation Agency) and Anthony Rivera (San Francisco Fire Department)
- ▶ **Seattle** - Christopher Eaves, Jude Willcher, Kristen Simpson (Seattle Department of Transportation)
- ▶ **Washington DC** - Stefanie Brody, Stephanie Dock, Laura Richards, and Jonathan Rogers (District Department of Transportation)

The authors also thank Chief Michael Myers of the Portland Fire and Rescue, Vicky Sims and Alina Tuerk Bill of Transport for London, Stremper of Fleetmasters, Inc., Ritchie Huang of Daimler Truck North America, and Skip Yeakel of Volvo Truck North America for key technical information and discussion.

Additionally, the authors are grateful to David Arthur, Mikio Yanagisawa, Don Fisher, Alisa Fine, and Emily Navarrete of the Volpe Center for technical and editorial review, and to Alex Engel and Celine Schmidt of the National Association of City Transportation Officials for editorial review, report layout, and design.

Table of Contents

- Introduction** 5
 - Key Findings 6
 - Safer Streets Through Vehicle Design..... 7
- Vehicle Downsizing** 10
 - Many Ways to Downsize 11
 - Capacity Comparison – Fire Trucks & Commercial Freight Vehicles..... 14
 - Benefits & Considerations in Vehicle Downsizing..... 20
 - Best Practice – Improved Direct Vision 22
 - Considerations for Implementation 25
 - Implementation Examples 30
- Appendices** 37
 - Appendix A: Project Scope and Structure 38
 - Appendix B: Cab-Over Safety Data Versus Perceptions..... 40
 - Appendix C: Turn Radius Vehicle Geometry Factors 41
 - Appendix D: Figures 43
 - Appendix E: References & Citations..... 44

Introduction

Large vehicles move goods and services that support thriving, livable communities and urban centers. However, these vehicles are disproportionately responsible for fatalities on U.S. roads. Nationally, large trucks comprise 4% of the U.S. vehicle fleet,¹ yet are involved in 7% of pedestrian fatalities, 11% of bicyclist fatalities,² and 12% of car and light-truck occupant fatalities.³ In 2017, 4,761 people were killed by trucks in the United States.⁴ Troublingly, NHTSA's most recent analysis of traffic fatalities shows that, despite a slight decline in overall fatalities in 2017, fatalities involving large trucks increased 9% over 2016 numbers.⁵

When it comes to traffic fatalities, vehicle size matters. Large trucks typically have blind spots that are larger than those of the average car, making it harder for truck drivers to see people or objects directly next to or in front of them.⁶ Decreased visibility can also cause drivers to react more slowly to impending collisions. The increased weight of large trucks also means that they stop more slowly than cars and, when they hit people, they do so with increased force. The relationship between vehicle size and increasing pedestrian and cyclist fatalities in the U.S. has also been documented beyond trucks. A recent Detroit Free Press report identified the increasing size of vehicles as the main factor in the U.S. rising fatality rate.⁷

Compounding the higher lethality risk inherent in large trucks, geometric street design choices are commonly constrained by the size and maneuverability of the largest vehicles on the road. The freight and delivery, municipal, construction, transit, and emergency response vehicles used in the U.S. often have wide turning radii and require significant space to maneuver and park. Designing streets around large vehicles increases the likelihood that drivers of smaller vehicles (cars and light-trucks) will travel at unsafe speeds. Although street redesign is widely recognized as a highly effective way to reduce traffic fatalities and injuries, the space needs of large vehicles often deter cities from implementing key safety treatments such as shorter crossing distances, reduced roadway widths and turn radii, pedestrian refuges at intersections, and physically protected lanes for pedestrians and bicyclists. Reducing the size, increasing driver visibility, and improving the maneuverability of large vehicles can give engineers the flexibility to make critical roadway safety improvements that can increase safety outcomes for everyone.

To address these safety challenges in the near-term, municipal and private fleet operators and policy makers can potentially reduce the number of fatalities involving large trucks by redesigning the vehicles themselves in ways that are more compatible with safe, vibrant city streets. Vehicle redesign is a near-term strategy that supports improved street design that can save lives. The spectrum of potential vehicle redesign ranges from minor retrofits that improve driver line-of-sight, to "downsizing," which means replacing aging fleets with newer, more maneuverable, and potentially more efficient vehicles. In addition, numerous technologies exist to improve a driver's ability to operate their vehicles safely, including in complex, multimodal, urban environments. As a significant percentage of trucks and buses in U.S. fleets are owned and operated by public agencies, vehicle redesign offers cities a unique opportunity to support Vision Zero efforts and increase safety on urban streets.

Key Findings

Vehicle downsizing, sometimes referred to as rightsizing, is a policy or practice of preferentially replacing existing vehicles with the smallest appropriate vehicles, potentially offering improved direct vision of other road users, improved maneuverability in urban environments, and reduced conflict with human-scale street geometry.

- ▶ **Encouraging or requiring vehicle downsizing can increase safety for pedestrians, cyclists, and drivers.** Smaller vehicles have less mass and, as a result, are less lethal when a crash occurs. Smaller vehicles are also often more maneuverable and have better sightlines, allowing drivers to better avoid crashes in the first place. As a systematic approach, reducing the size of the largest vehicles would allow cities to deploy a wider array of traffic calming techniques in more places, which would reduce the likelihood of speeding and other reckless driving from all drivers, regardless of vehicle type.
- ▶ **Accommodating the largest vehicles on the street — often emergency response vehicles or municipal refuse vehicles — prevents cities from redesigning streets for safer speeds and reduced crossing distances.** Even as street designs with narrower lanes, smaller turning radii, and decreased crossing distances are shown to increase street safety, larger vehicles require wider lanes, larger turning radii, and significant space to maneuver and park, preventing street designers from making street improvements that improve safety for everyone.
- ▶ **Smaller, more maneuverable emergency response trucks often have similar, or better, capabilities than the most common trucks on the streets in U.S. cities today.** Aerial ladder fire trucks used in major European and Asian cities can reach just as high, despite being only two-thirds as long and having only half of the turn radius as common American models. Some models of pumper fire trucks are up to 30% smaller, and have a turn radius up to 50% less than more typically procured models.
- ▶ **More specialized emergency response operations may allow for further improvements in street design, as well as improved emergency response times.** Multiple cities studied use motorcycles and/or bicycles in lieu of or to supplement full-size fire and ambulance trucks for medical calls. Many cities likewise use smaller equipment in selected congested or constrained areas, enabling cities to redesign streets in those areas using best street design practices for safe speeds and improved pedestrian and cyclist visibility.
- ▶ **Increased direct vision from the truck cab, a frequent result of vehicle downsizing, also has unique safety benefits.** Findings related to direct vision enhancements include:
 - ▶ **Trucks with improved direct vision can markedly decrease operator reaction time — up to 50% faster than through indirect vision (mirrors, backup cameras, etc.) — with minimal additional cost.** When tested in a simulation, more than half of distracted drivers in traditional cabs struck a pedestrian, while only 12% of high-vision cab drivers did. High-vision truck cabs cost 0-5% more than conventional cabs — costs that may be recouped over time with decreased insurance and crash liability claims.
 - ▶ **Many design elements that improve driver visibility can be retrofitted onto existing fleets, enhancing safety more rapidly than typical vehicle replacement cycles.** Peep windows, teardrop windows, and reduced window tinting can generally be retrofitted onto existing vehicles, providing immediate safety benefits.

Safer Streets Through Vehicle Design

Vehicle downsizing and associated direct vision improvements decrease the time it takes for a driver to see a person, apply the brakes, and come to a stop to avoid a crash. For example, at 25 mph the driver with improved direct vision may stop in about 90 feet, whereas the driver with indirect vision may not stop until 120 feet. The sooner a person is detected, the sooner the brakes can be applied, and the less likely the vehicle is to strike, injure or kill them. Critically, because larger vehicles have longer stopping distances, increasing the amount of time that the driver has to recognize and react to a conflict is key to reducing crashes and fatalities. In addition, reducing vehicle size and increasing direct vision from the cab allows the driver to establish eye contact and communicate, see and anticipate more people, and do so reliably at night or in bad weather.

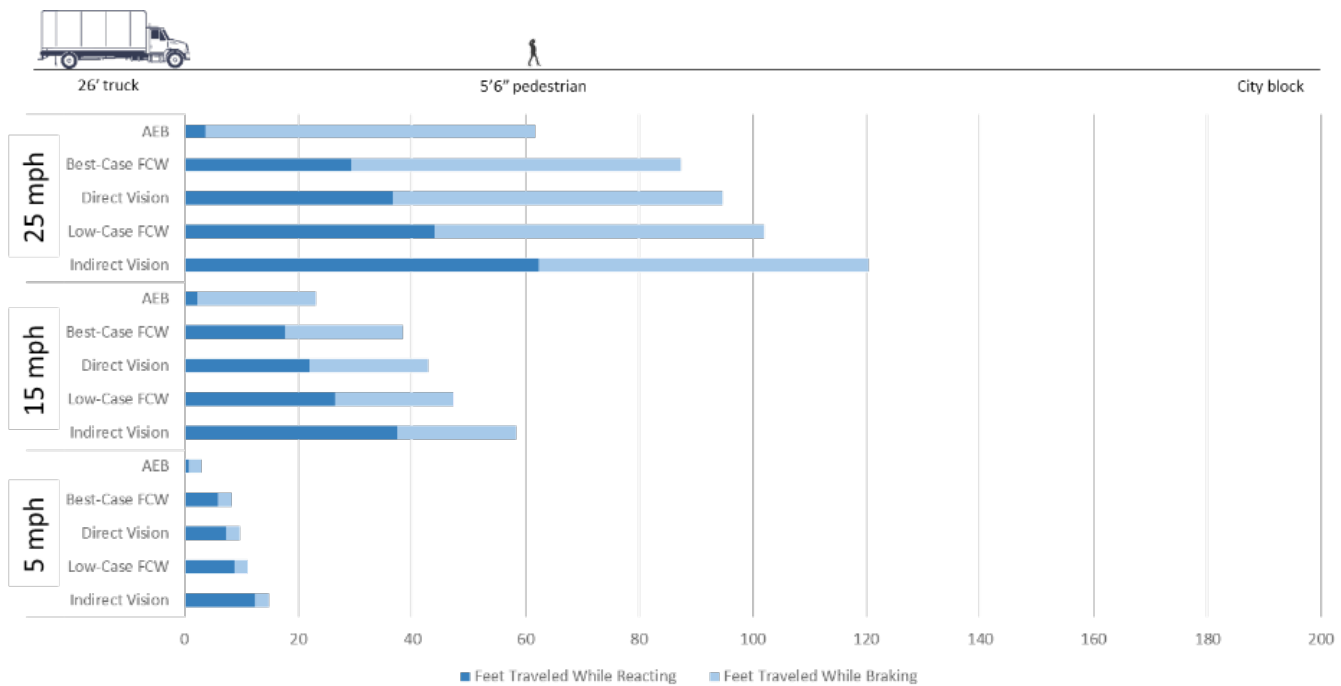

Figure 1: Response times and truck braking distances by speed and technology type. The objective at any speed is to move from the bottom bar (indirect vision) to the top three bars (direct vision, best-case Forward Collision Warning/FCW, and Automatic Emergency Braking/AEB) because the driver or vehicle will detect a person sooner.

Downsizing and increasing the visibility from the cab can mean safer larger vehicles on today's streets, but the benefits do not end there. Smaller, downsized vehicles typically have increased maneuverability, which allows cities to implement a wider array of life-saving traffic calming street designs. For instance, San Francisco's newly introduced "triple combination pumper" fire truck made by Ferrara Fire Apparatus, is smaller than its predecessor by a matter of inches but boasts a turning radius that is 25% smaller (25' vs 33'), allowing for a significant improvement in vehicle maneuverability.⁸ Similarly, operators have found that transitioning from conventional cab-forward vehicles to cab-over vehicles allows for increased safe operations on narrow streets and in intersections with tight curb radii. Strategic adoption of these types of vehicle design changes allows traffic engineers the freedom to implement more robust safety designs without worrying about vehicle access. Especially in older, more space-constrained cities, requiring, promoting, or encouraging the use of cab-over vehicles may also offer additional benefits by reducing the space required to park or store vehicles.

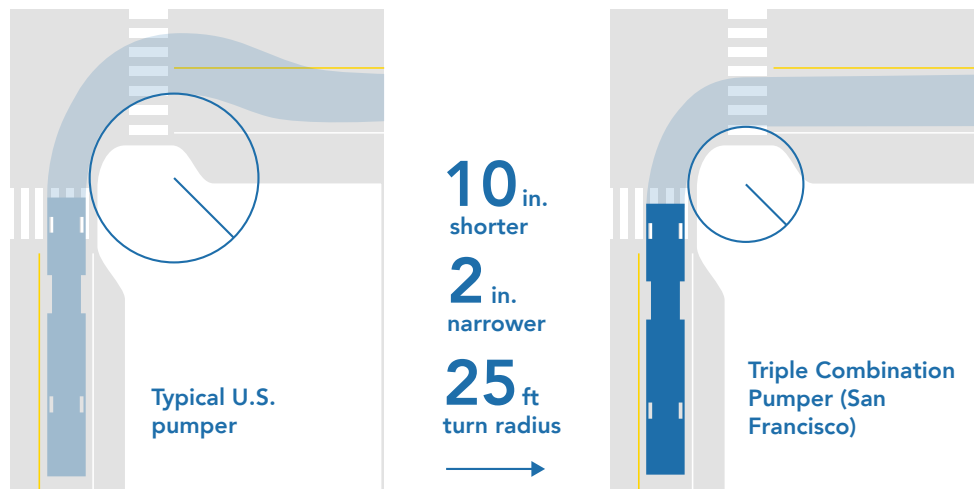

Figure 2 (top): Differences in turn radii between pumper trucks. Left - standard pumper truck. Right - Triple Combination Pumper by Ferrara Apparatus as used in San Francisco. Image: NACTO

Figure 3 (bottom): San Francisco Ferrara Apparatus.

Improved direct vision is especially important for trucks and other large vehicles. For example, the blind spots of a “worst-in-class” conventional cab dump truck can hide a bike lane or the entire width of a crosswalk at an intersection. While most current intersection and bike facility designs account for passenger car blind spots, trucks’ blind spots are typically larger and vary more extremely by make and model. Downsizing or replacing such a large truck with a higher vision alternative can significantly reduce the blind spot threat to pedestrians, cyclists, and other road users.

Blind spot sizes vary by truck model and pedestrian height

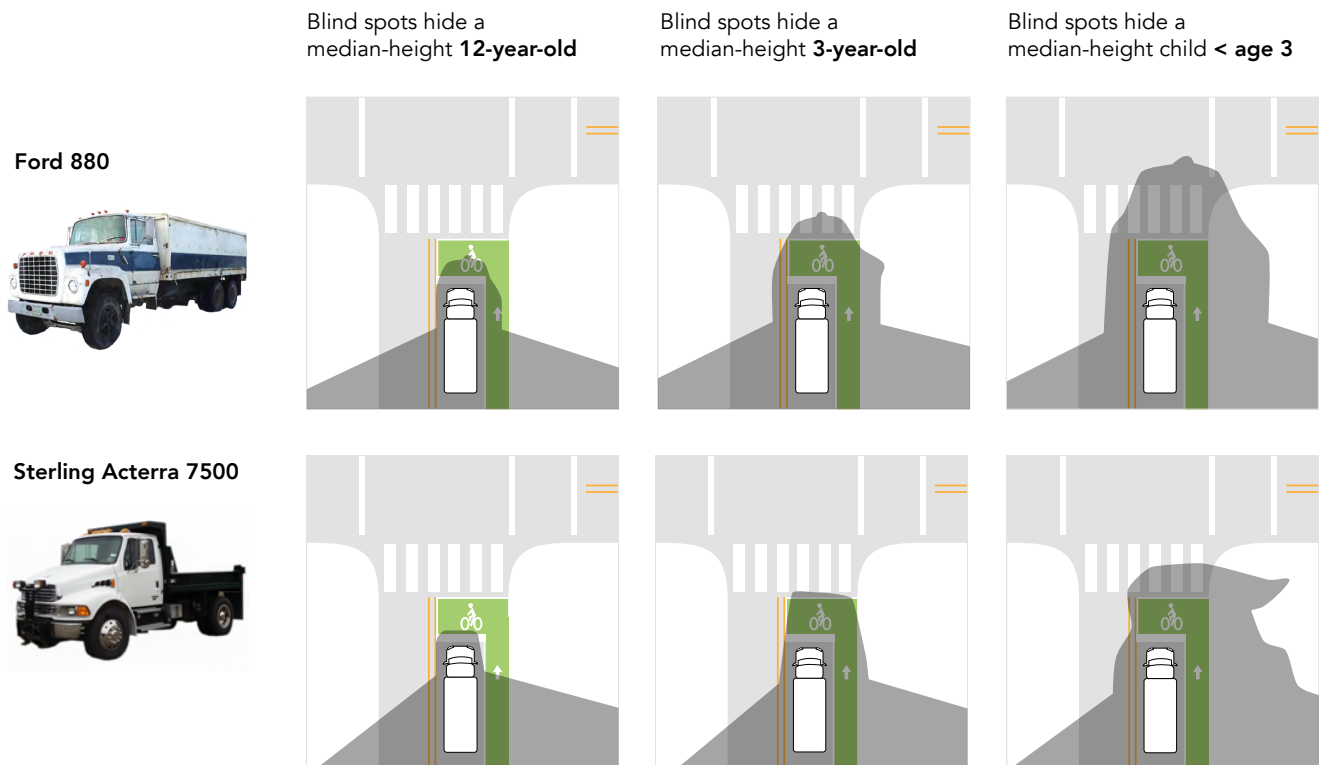

Figure 4: A vehicle with smaller blind spots better allows a median-height driver to see people in a bike box or a crosswalk, especially children. For the 50% of drivers who are below median height, the blind spots are actually larger than shown.¹⁰

Vehicle downsizing and associated increased direct vision are key tools in a package of safety enhancements. To increase opportunities to reduce crashes, cities and fleet operators should peruse parallel implementation tracks, retrofitting direct vision designs (e.g. peep windows) into vehicles that are not scheduled for replacement or overhaul in the near future, while including downsizing requirements into procurement contracts for future vehicles. Concurrently, cities should also implement pedestrian-focused street design strategies that increase physical separation between people and vehicles, improve sightlines, reduce speeds, and narrow crossing distances.

Lastly, the availability of vehicle designs and technologies is largely driven by customer demand, which in turn is largely driven by awareness, policy, and economics. Crucially, a significant percentage of trucks and buses in U.S. fleets are owned and operated by public agencies.⁹ A critical mass of coordinating city fire departments, for instance, could likely influence the design of future fire apparatus offered in the U.S.¹⁰ With city fleets leading implementation, additional vehicles such as garbage trucks, public works trucks, and transit vehicles could follow fire apparatus in incorporating downsizing as part of fleet replacement and vendor procurement. As municipal fleets demonstrate demand, new opportunities for downsizing might also present themselves for the private market. This dynamic presents cities with an opportunity to lead the implementation of safer large vehicle designs through retrofits and new purchases of certain vehicle-based safety technologies.

Vehicle Downsizing

Vehicle downsizing, sometimes referred to as rightsizing, is a policy or practice of preferentially replacing existing vehicles with the smallest appropriate vehicles, potentially offering improved direct vision of other road users, improved maneuverability in urban environments, and reduced conflict with human-scale street geometry. Vehicle downsizing options can range from adjusting dimensions of vehicles (e.g., replacing a truck with a differently designed, smaller truck) to restructuring operations practices to allow for the use of different types of vehicles (e.g., using EMTs on bicycles or motorcycles to respond to certain emergency calls).

Vehicle downsizing presents opportunities to increase safety in three major ways:

1. By reducing the size and mass of vehicles operating on urban streets, thereby reducing their lethality when a crash occurs
2. By increasing the maneuverability of the vehicle and the driver's ability to see the road, thereby reducing the likelihood that a crash will occur
3. By reducing the street width and turn radii required for vehicle passage, thereby increasing opportunities for cities to introduce life-saving, traffic calming street design treatments and increase protected space for pedestrians and cyclists

This section provides information about the benefits, limitations, and implementation considerations associated with vehicle downsizing and then provides a deeper exploration of best practices associated with **Direct Vision Improvements**. In addition, this section provides a **vehicle capacity comparison for fire trucks and box trucks**, and identifies the makes and models of fire trucks currently on the market that can increase maneuverability versus conventional U.S. fire trucks without sacrificing firefighting capacity.

Many Ways to Downsize

It is important to recognize that downsizing does not mean simply replacing a large truck with a smaller truck. Rather, vehicle downsizing can include a range of vehicle design changes and replacements, all of which work to increase vehicle maneuverability and the driver's ability to see the road. Opportunities for changes to vehicle design include changes to:

- ▶ Wheel cut/cramp angle and wheelbase
- ▶ Steering configuration
- ▶ Cab height, design, and window placement

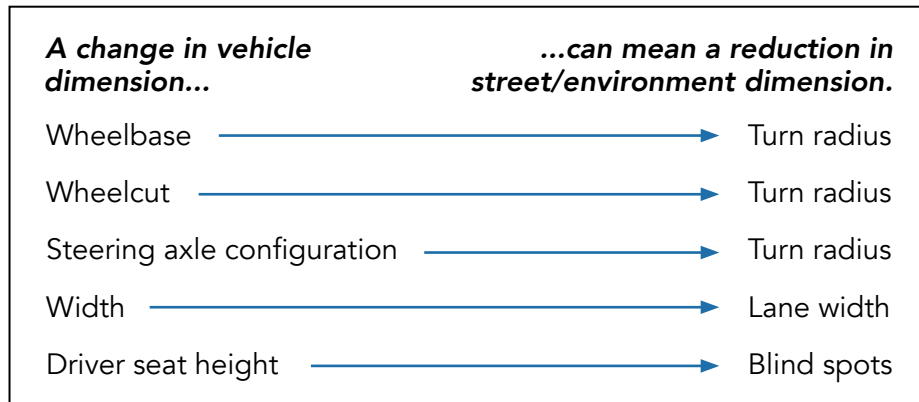

Figure 5: Small changes in vehicle dimensions can significantly reduce blind spots and the amount of space required on the road.

Opportunities for vehicle design changes

Wheel cut/cramp angle and wheelbase

Two factors determine curb-to-curb turn diameter, i.e., the minimum street width for a vehicle to perform a U-turn. These are the wheel cut (maximum turn angle of the steering axle) and the wheelbase (distance between front and rear axle). Both can be changed independently of the overall vehicle length, which offers opportunities to increase maneuverability without impacting capacity. Vehicle width can also be varied separately from length, affecting narrow lane operation. For example, most school buses are 96 inches wide, six inches narrower than most transit buses.^{11,12,13}

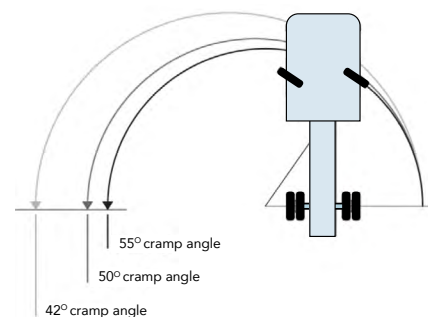
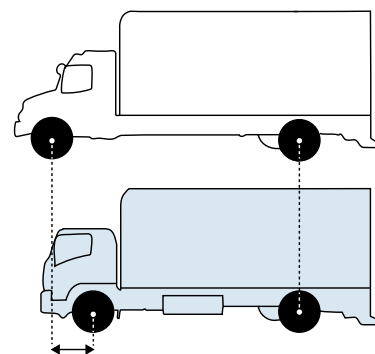

Figure 6 (top, on right) Cab-over trucks have a shorter wheelbase for a given body length and payload, permitting tighter turn diameters. Image adapted by NACTO

Figure 7 (bottom, on right): Trucks with a tighter wheel cut (called "cramp angle" for fire apparatus) also have a smaller turn diameter.¹⁴

Steering configuration

Steering configuration refers to whether a rear steer axle is provided to reduce the turn radius of a 3-axle truck or bus¹⁵ to more safely navigate city streets, reducing the risk of the rear wheels mounting curbs when making turns. Rear-steer axles, often known as tag axle steering or steerable tag axles, are to a limited extent available¹⁶ on U.S. trucks, but they have been a common feature for years on U.S. motor coaches¹⁷ and RVs¹⁸ as well as on European trucks¹⁹ (see Figure 8). They are also available, though less common, on some trailers, and have even been available on U.S. fire apparatus.²⁰

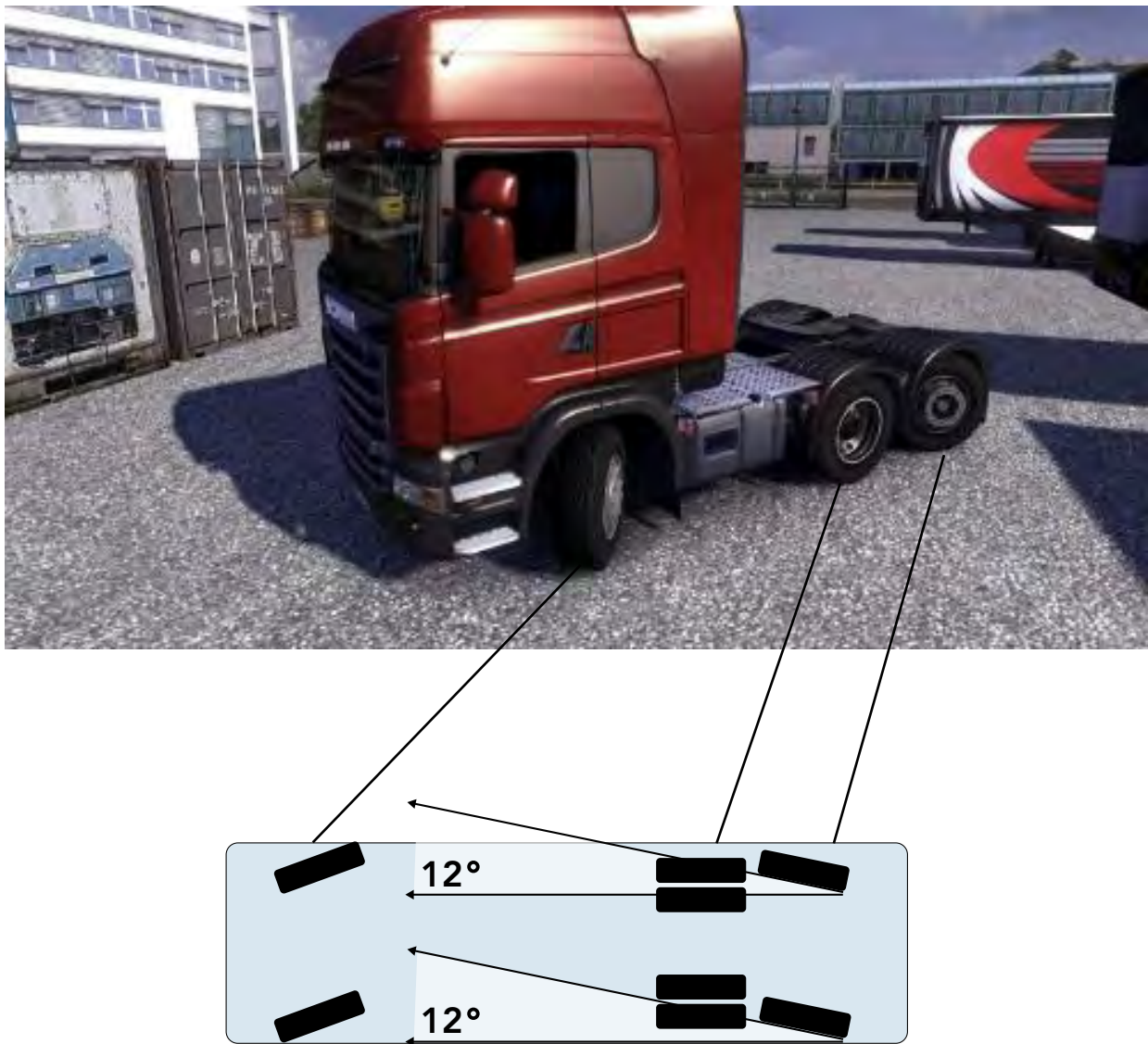

Figure 8. Tag axle steering reduces turn radius for safely navigating tight quarters.²¹ (Note: top image shows wheels on the rear tag axle rotated in a direction opposite the wheels on the front axle, as demonstrated in the bottom diagram.)

Cab height, design, and window placement

Finally, reduced cab height is already a common feature in refuse, emergency response, and courier trucks, which drivers frequently board and exit. This dimension is independent of the size of the vehicle. It can improve visibility and help the driver to make eye contact and communicate intent with nearby pedestrians and cyclists. Similarly, changes to window placement and modifications to the design of the vehicle hood can also significantly improve visibility of and communications with people outside the vehicle. Examples of changes to window placement include retrofitting in “peep” windows to allow drivers to see people and objects directly alongside or purchasing high-vision cabs featuring expanded windows. Vehicle hood design options include sloped hoods and cab-over models.



Figure 9: Low-entry cabs and additional “peep” windows in truck cabs let drivers see adjacent people and objects



Figure 10: The Mitsubishi Fuso Canter, pictured here in New York City, features a low-entry, reduced height cab which increases the driver’s ability to see people and objects.

Capacity Comparison: Fire Trucks & Commercial Freight Vehicles

Smaller Size Does Not Always Mean Reduced Capacity

When considering downsizing as a safety strategy in an urban truck or bus fleet, it is important to be able to understand possible tradeoffs in performance or capability. While a shorter or narrower vehicle may not have the same payload or capacity, the vehicle may still be equally capable of performing its intended job, while having a tighter turn radius and more safely navigating downtown streets. A truck or bus with a 20 percent shorter wheelbase has a minimum turn radius that is also 20 percent smaller. Indeed, a smaller vehicle with greater maneuverability can offer more efficient operation through more direct routing and fewer delays in dense traffic. Road diets provide a useful analogy. Road diets involve reallocating inefficiently used road space for a more multimodal street with similar or even higher capacity to move people.²² Like streets, certain inefficient large vehicle designs can be made more compact while maintaining if not increasing their capacity.

In addition, reductions in absolute capacity can potentially be addressed by policy changes regarding freight and goods movement; these may include improved curbside management, designated delivery hours or routes, and urban-scaled distribution hubs.²³ Since smaller vehicles afford benefits to the cities in which they operate, it is reasonable to consider a holistic solution to their implementation that takes into account the need for public sector cooperation and coordination.

One oft-posed potential unintended consequence of downsizing (specifically, reducing truck capacity) is increased congestion and increased crashes. This assumes that current trucks are loaded to capacity and that reducing individual vehicle capacity therefore requires more trucks. However, load factors of trucks can vary on average from approximately 50% to 90%.²⁴ In the U.S., shippers typically hire a full truckload (FTL) freight carrier instead of a less-than-truckload (LTL) carrier even when their cargo uses only as little as 25% of the trailer's capacity²⁵. Still if current trucks are assumed to all be loaded to capacity, the possible unintended consequence is that, for example, three smaller trucks will generate more vehicle miles traveled and more potential for collisions than two large trucks. If so, it is difficult to predict whether the number of injury crashes would increase or decrease. It is possible that each individual small truck would generate fewer injury crashes due to improved visibility and maneuverability, or due to other factors that offset the increase in truck miles. Small trucks may more easily fit in loading zones without double parking, a common cause of urban congestion. Additionally, miles traveled by smaller trucks may not increase as expected if local distribution centers proliferate (e.g., Amazon urban fulfillment centers²⁶) and disrupt today's last-mile logistics patterns.

Downsizing Fire Trucks

Member cities in the Working Group reported that the size of today's fire apparatus can limit cities' ability to implement lower-speed streets and intersections for pedestrian, cyclist, and vulnerable road user safety. Wide suburban roads and sprawl in the second half of the last century have allowed fire apparatus manufacturers to design increasingly larger vehicles that assume 20 to 26 feet of clear width on every street in their service areas. These larger fire apparatus can be incompatible with many existing streets in older cities and towns. In many communities, smaller vehicles could potentially help emergency response personnel reach more building stock and population in less time, in addition to allowing designers to implement more compact, safer street designs.

Based on Volpe's research, as well as interviews with Portland, OR and San Francisco, CA fire officials, it is clear that U.S. fire apparatus have significantly grown in size over the past century, paralleling growth

in the size of freight trucks.²⁷ New equipment has been added to fire trucks to address new types of emergencies (e.g., gas leak, hazmat, biochemical attack, etc.) as building fires have diminished to approximately 3-5 percent of incident calls nationally.²⁸ Fire apparatus have grown in size to the point that emergency vehicles were recently exempted from federal truck weight limits, even though many non-Interstate Highway bridges are not designed for up to 92,000 pound fire vehicles.²⁹ According to the Federal Highway Administration Office of Bridges and Structures, "...bridge safety, serviceability, and durability might be compromised by these [fire apparatus]."³⁰

Fire apparatus include two principal types: pumpers (or "engines"), which supply water or foam, and aerial ladder trucks, intended to provide aerial access for firefighters, evacuees of a building, and pumped water or foam. Ladder trucks are larger than pumpers yet must generally be able to access all streets in a city.³¹ As most states have adopted the International Fire Code, which authorizes fire departments to stop street construction and modification projects, ladder trucks have at times become the limiting factor constraining traffic fatality reduction projects, livable street design, and traffic calming initiatives.³²

Assessing ladder truck performance

According to the Portland, OR Fire Department, the key performance metrics for a ladder truck are ladder height (vertical) and reach (horizontal), as well as pumping capacity. Fire departments in Europe and Japan operate significantly smaller vehicles, and there appears to be renewed attention in the U.S. fire service community on how improved fire suppression and pumping technology can permit downsizing a fire apparatus while maintaining capability.³³

There are other differences between U.S. and international fire departments, including that some international agencies use different vehicle types depending on the emergency call received. One notable example is the use of motorcycles for EMT response and triage in some cities, which can significantly increase the speed of response because of those smaller vehicles' ability to navigate narrower and/or more congested streets. Daytona Beach and Austin-Travis County are two U.S. jurisdictions that have already incorporated motorcycles into their fire EMT response operations. Importing similar approaches to other U.S. cities, in addition to fire engine and ladder truck designs, could provide a more comprehensive approach to maintaining and even improving emergency response capabilities while giving street designers more flexibility to create environments that better accommodate and protect all road users.

Comparing the performance of European and American fire trucks

Aerial ladder trucks used in major European and Asian cities such as London and Tokyo provide equivalent or greater ladder height and reach with improved vehicle maneuverability. European aerial ladder apparatus can reach just as high, with two-thirds the vehicle length and up to half the required turn radius.³⁴ European and Asian models are likewise significantly lighter.³⁵

Notably, the 2009 revision of NFPA 1901 allows for the use of European-style ladders in the U.S, which may open the door for European apparatus designs not available before. Almost all European aerials have platforms on which firefighters can stand, and some offer removable platforms. These aerial designs appear to be more targeted for urban areas with narrow streets than current U.S. designs.³⁶

Additional approaches available for reducing the footprint of ladder trucks include smaller stabilizers and stabilizers that can be shortened or only deployed on one side ("short-jacked"). This can reduce width requirements at a fireground by 10 feet, for example requiring only 9 feet instead of 19 feet of additional width.³⁷

Comparing Aerial Ladder Trucks

**E-One Cyclone HP 95
Ladder Truck**

**Magirus M32L-AS
(Iveco 160 E 30)**



		
Region	United States	Europe
Turn radius		
Wheel base	260 in.	190 in.
Overall length	574 in.	393 in.
Ladder height	95 ft	105 ft
Ladder reach	87 ft	91 ft
Visualized ladder radii		
Ground line		

Figure 11: Comparing the Performance of European and American Fire Trucks. Image adapted by NACTO

Comparing Aerial Ladder Trucks (continued)

Seagrave TDA Tiller Aerial Ladder

Magirus 42L-AS Ladder (Iveco 180 E32)

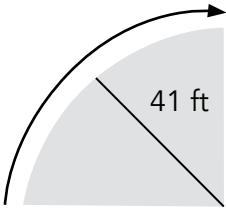
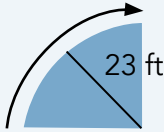
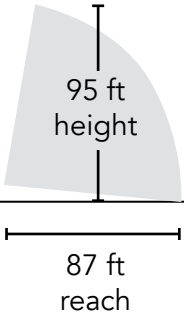
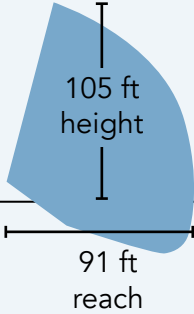







Region	United States	Europe
Turn radius		
Wheel base	155 in. tractor; 305-341 in. trailer	201 in.
Overall length	684-720 in.	504 in.
Ladder height	100 ft	138 ft
Ladder reach	91 ft	82 ft
Visualized ladder radii		
Ground line		

Figure 11 continued: Comparing the Performance of European and American Fire Trucks. Image adapted by NACTO

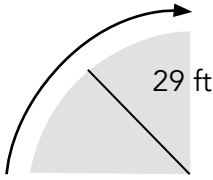
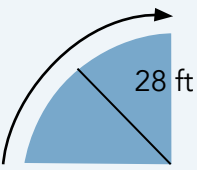
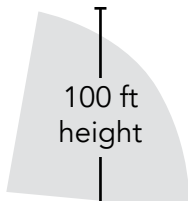
Comparing Pumper Fire Trucks

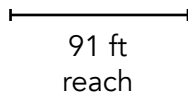
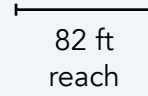
For pumper trucks, some smaller sized, similar capacity vehicles are already in use in the U.S. In San Francisco, the SFFD pumper maintained pumping capacity but reduced turning radius by 24% (from 33 ft to 25 ft). Even smaller vehicles such as the “Rapid Attack Apparatus” pumper are available with no further reduction of carrying or pumping capacity. Fire pump capacity can be maintained across vehicle sizes.

	Standard Pumper	SFFD Pumper	“Rapid Attack Apparatus” Pumper
			
Carrying capacity	750 gallons	500 gallons	500 gallons
Fire pump capacity	1,500 gal/minute	1,500 gal/minute	1,500 gal/minute
Turn radius			
Wheelbase	201 in.	169 in.	129 in.
Overall length	384 in.	334 in.	266 in.

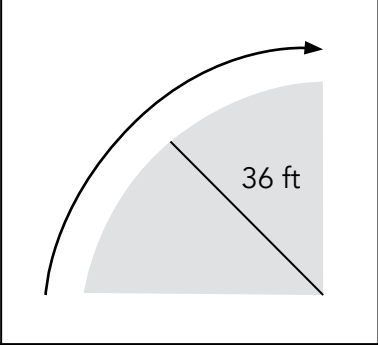
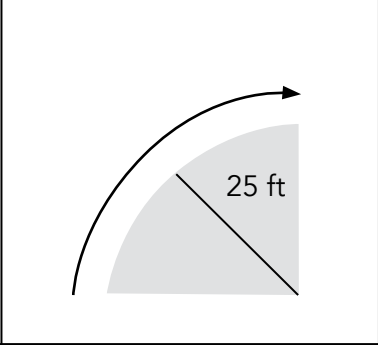
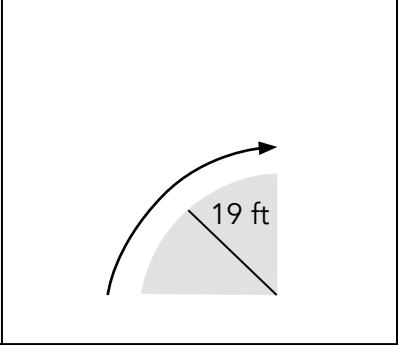
————— Same pumping capacity, smaller turning radius —————>

Figure 12: Comparing the Performance of European and American Fire Trucks. Image adapted by NACTO

Downsizing Commercial Freight Vehicles

Opportunities for vehicle downsizing without negative impacts on capacity also exist for commercial freight operators. Preliminary comparison research shows that at the same Gross Vehicle Weight Rating (GVWR) (which tracks with payload capacity), it is possible to get both tighter turn radius *and* a larger cargo body.





	Rigid	Rear Steer	Conventional	Cab-over
				
Axles	3-axle		2-axle	
Max cargo body length	30 ft	25 ft	24 ft	28 ft
Overall length	454 in.	Not available	463 in.	414 in.
GVWR	52,000 lbs	52,000 lbs	33,000 lbs	33,000 lbs
Turn radius				
	Same GVWR, smaller turning radius		Same GVWR, longer cargo body, smaller turning radius	

Figure 13: Comparing the Performance of Commercial Freight Vehicle Models. Image adapted by NACTO

Benefits & Considerations in Vehicle Downsizing

Vehicle downsizing represents a key opportunity for cities and private fleet operators to reduce risks to pedestrians, cyclists, and other vulnerable road users by deploying vehicles that are more compatible with operation in dense, urban settings.

This report identifies a number of benefits associated with vehicle downsizing. These include:

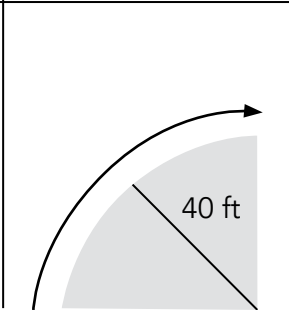
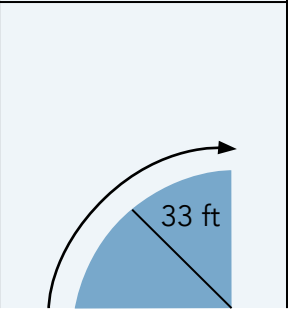
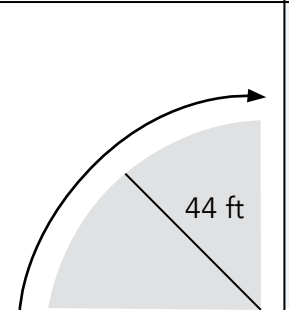
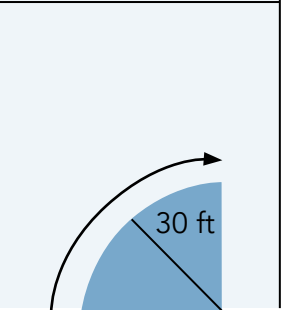
- ▶ Can improve drivers' situational awareness
- ▶ Can improve operational safety
- ▶ Can leverage existing budget & procurement cycles

At the same time, research suggests some areas where additional considerations must be taken into account as operators downsize or rightsize large vehicles. These include:

- ▶ Potentially long full fleet replacement timeline
- ▶ Possibility of less-credentialed drivers

Benefits of Downsizing

Can improve drivers' situational awareness

Smaller vehicles can offer improved visibility and provide the driver with greater situational awareness to see and avoid collisions with people in the vicinity of the vehicle. Improved visibility of nearby road users is a function of the driver's height from the ground, how low the cab glazing extends on all sides, and the geometry of the dashboard, hood, doors, and pillars.

Can improve operational safety

Improved operational safety can stem from downsized vehicles' reduced turn radii and off-tracking of the rear wheels, which can reduce associated curb mounting and endangerment of people when making turns at intersections and driveways, as well as potentially reduce damage to street infrastructure. Reduced encroachment on sidewalk extensions, median refuges, adjacent travel lanes, bike lanes, and bike boxes³⁸ can similarly translate to safety improvements for people. This operational benefit is two-fold, as it allows street designers to implement more of these safety features as part of roadway and streetscape projects for improved access, mobility, and safety.

Can leverage existing budget & procurement cycles

Vehicle downsizing represents a unique opportunity for fleet operators because it makes use of pre-planned, regular vehicle replacement schedules to acquire new, smaller vehicles. In doing so, the cost of downsizing is typically already budgeted for. However, as large vehicle fleet turnover can take over a decade, downsizing is a longer-term strategy than ADAS. Two possible ways to accelerate the impact of downsizing are prioritizing the assignment of existing downsized vehicles to areas where they may be most beneficial, such as the use of motorcycles for EMT response and triage; and using municipal contracts to select for vendors with access to rightsized vehicles, so that they are available as required when fleet vehicles are replaced. Downsizing places emphasis on identifying new vehicles that support collision avoidance through improved situational awareness and greater operational compatibility with urban street design that supports multimodal safety and access.

Challenges and considerations for downsizing

Potentially long full fleet replacement timeline

As noted above, full large vehicle fleet turnover can take over a decade, depending on the size of the fleet. As such, some of the safety benefits of downsizing, such as opportunities for street redesign, may not be immediate. One way to accelerate the impact of downsizing is to have cities or operators focus the assignment of existing downsized vehicles to areas where they may be most beneficial, such as the use of motorcycles for EMT response and triage. Cities should also explore procurement options proactively, to ensure that they are able to select vendors with access to rightsized vehicles, so that they are available as required when fleet vehicles are replaced.

Possibility of less-credentialed drivers

The first possible unintended consequence is that downsizing might increase the proportion of less-qualified drivers operating smaller trucks. This concern is related to the fact that driving trucks with gross vehicle weight ratings up to 26,000 pounds does not require a commercial driver license (CDL). However, it is not clear whether non-CDL drivers operate a given vehicle less safely than CDL drivers. Volpe could not identify research that has addressed this question. Complicating the issue are the facts that (1) no national statistics appear to exist that compare the crash rates of CDL versus non-CDL truck operators;³⁹ (2) safety performance is federally measured at the commercial motor carrier (company) level rather than the driver level; and (3) there is no minimum training requirement currently in place to obtain a CDL.⁴⁰ Since CDL driver convictions can be better tracked than non-CDL driver convictions spread across different states,⁴¹ the least safe CDL drivers can potentially be identified and more easily held accountable over time than the worst non-CDL drivers. However, companies employing non-CDL drivers may also invest more in training them to minimize crashes and protect their reputation.⁴² In short, it is difficult to predict whether more or fewer injury crashes would result from a larger fraction of non-CDL urban truck drivers.

Best Practice: Improved Direct Vision

Heavy-duty vehicles are less maneuverable and take longer to stop than light-duty vehicles. As a result, reducing driver reaction time is a key tool to improving safety. Direct Vision improvements, such as high-vision cabs and peep windows, may start low on the priority list of cities seeking to invest in more “high tech” solutions for their fleet safety. However, the ability of Direct Vision improvements to enhance a driver’s direct field of vision by reducing large blind spots is one of the key tools operators have to reduce safety risks presented by their vehicles. Increasing municipal drivers’ direct vision from the cab may also help cities and operators reduce costs associated with city insurance and crash liability claims.

Direct Vision improvements consist of a wide slate of related tools, some of which can be retrofitted onto existing fleet vehicles and others which must be specified in the purchase of new vehicles, in some cases at no added cost. Often, retrofits and short- and long-term procurements can be combined to create meaningful safety improvements incrementally. Elements of Direct Vision include:

- ▶ Peep & Teardrop Windows
- ▶ Sloped-hood Cabs
- ▶ Cab-Over Engine Designs
- ▶ High Vision Cabs (includes cab-over & window enhancements)

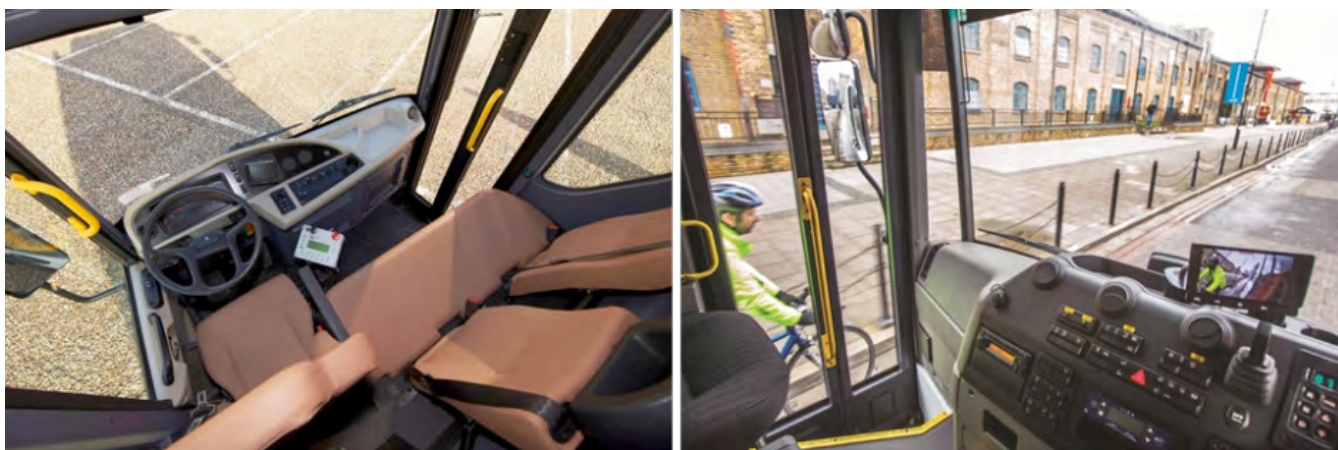

Figure 14: High-vision cabs expand near-vehicle visibility for drivers. Courtesy of Transport for London.

What Are High-Vision Cabs?

Whereas other vision-enhancing mechanisms—e.g., mirrors, lenses, cameras, and sensors—are intended to compensate for poor direct vision, high-vision cabs allow drivers to better see adjacent roadway, pedestrians, cyclists, and other road users with their naked eyes. This minimizes the complexity and fatigue potential of processing multiple inputs, reduces new blind spots created by the installation of mirrors, and facilitates eye contact with people to communicate awareness and intent through facial or hand signals. There are several key components of high-vision cab design that distinguish it from traditional cab design:

- ▶ Cab-over or cab-forward design, wherein the driver sits forward of the front axle (versus conventional cab design wherein the engine and front axle are forward of the driver)
- ▶ Lower driver seat height and reduced dashboard height/size to allow a better view of surroundings
- ▶ Increased glazing and lower windowsills throughout the cab body and doors.

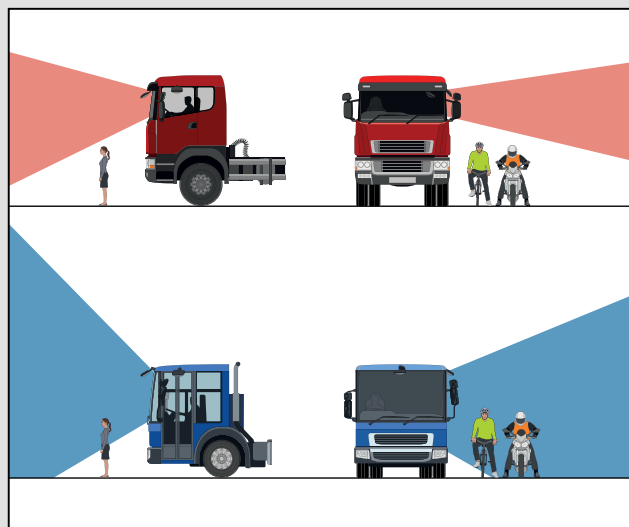

Figure 15 (top): The Mercedes Benz Econic MGT Euro5 high-vision cab in use for freight in Europe.

Figure 16 (middle): Sightlines from a limited direct vision heavy goods vehicle versus an increased direct vision model. Image courtesy of Transport for London.

Figure 17 (bottom): View of a cyclist from a high-vision truck cab.



Direct vs. Indirect Vision

A limited but growing body of primarily international studies establishes the effectiveness of improved direct vision in reducing crashes and injuries. A 2006 University of Michigan study found that 20 percent of truck-initiated crashes are linked to poor direct vision and noted that direct vision is currently unregulated in the U.S.⁴³ In the United Kingdom, Loughborough University has linked truck-person crashes to the level of direct vision in the involved vehicle. Construction vehicles and above-average cab height with low levels of direct vision correlated with involvement in fatal crashes with bicyclists in London.⁴⁴

Transport for London's Freight and Fleet Office commissioned studies of direct vision, including synthesis of literature, extensive driver surveys, and laboratory-based experiments.^{45,46} Results from a University of Leeds study showed that driver responses to seeing a pedestrian were on average 0.7 seconds faster by direct vision than by indirect vision, i.e. through mirrors. Viewing pedestrians indirectly doubled the driver response time and thus doubled the distance traveled before the driver could apply the brakes or steer to avoid a crash.⁴⁷

In addition, compared to indirect vision (e.g. cameras or mirrors), driver direct vision introduces fewer human factor concerns and caveats. Continuously checking multiple mirrors and camera screens can lead to input fatigue for the operator, potentially reducing the safety benefit of these add-on devices. Hence direct vision allows drivers to respond more quickly to avoid a crash than does indirect vision.^{48,49,50}

Drivers in direct/high-vision cabs out-perform drivers in standard cabs, even when distracted

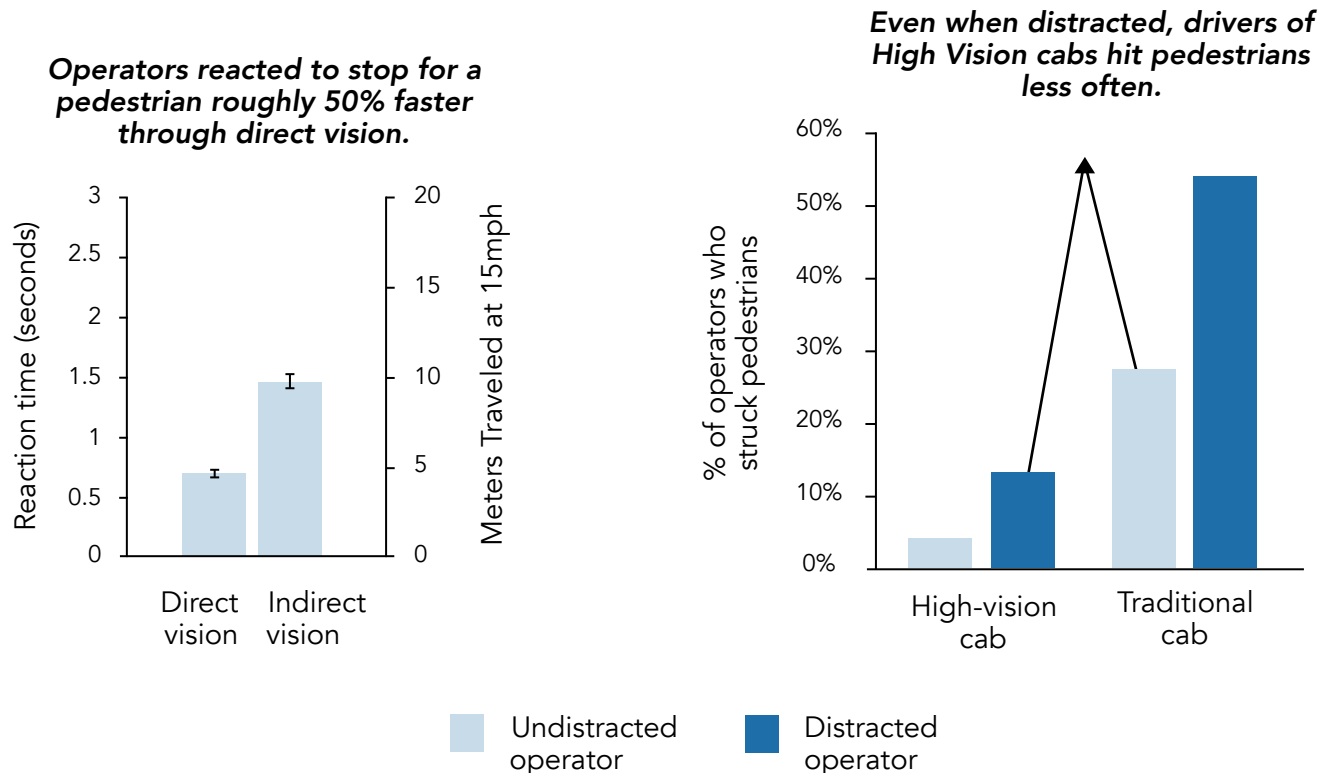

Figure 18: Left: Improved driver response time for direct compared with indirect vision. Right: Increase in crashes with pedestrians when using a traditional cab versus a low-entry, high-vision cab. (Source: TfL) Image adapted by NACTO

Evidence of Effectiveness

In the University of Leeds Study, the number of drivers in the study who struck simulated pedestrians was about five times greater in the traditional cabs than in the low-entry, high-vision cabs. When the drivers—which included professional truck drivers—were required to perform a mental task while operating, more than half of the drivers in traditional cabs struck pedestrians, compared to only about 12% of high-vision cab drivers. The findings suggest that distracted truck operators may especially benefit from a direct line of sight to people to avoid collisions.⁵¹

User accounts of improved direct vision offered by even small additional “peep windows” in the passenger door appear to corroborate the safety benefit of increased driver situational awareness. Milwaukee County recently purchased new snow plows equipped with peep windows (see example in Figure 31) and reported: “With the peep window on the passenger side door, they can see what’s happening...without leaning toward the window.”⁵² A U.S. trucking magazine that test drove truck models with peep windows noted their improved visibility in the passenger-side blind spot due to the additional glazing.⁵³

Volpe interviews with municipal fleet officials indicate a general awareness that cab-over trucks tend to have smaller blind spots than long-nose conventional cabs. The City of Boston preferentially dispatches cab-over Public Works trucks to downtown neighborhoods for this reason.⁵⁴

Considerations for Implementation

When selecting tools to increase the drivers’ direct vision, cities and private operators should look carefully to ensure that the selected tools meet their safety goals, be cognizant of system limitations, and identify resources and opportunities to address driver concerns.

In particular, purchasers should consider:

- ▶ How can they best combine high-vision cab elements, via retrofits and short- and long-term procurements, to transform their fleets?
- ▶ How can workplace safety be improved through Direct Vision tools like low-entry, cab-over-engine models?
- ▶ What driver perceptions must be addressed to ensure smooth transition to new cab types?
- ▶ How will they assess claims about the degree of vision possible?

How can they best combine high-vision cab elements, via retrofits and short- and long-term procurements, to transform their fleets?

A combination of retrofits and short- and long-term procurements may allow for either an incremental or a transformative approach to improving direct vision on a truck fleet. Peep windows, teardrop windows with lower windowsills, and reduced window tinting⁵⁵ can generally be retrofitted on existing vehicles. Sloped-hood conventional cabs (similar to the cabs of most newer school buses) can be specified on certain new trucks instead of boxy hoods at no marginal cost.⁵⁶ Furthermore, cab-over models can supplant conventional cabs, offering both increased maneuverability (due to reduced wheelbase) and improved direct vision. Ultimately, low-entry, high-vision cab-overs with maximum windshield and door glazing offer the greatest potential for improved direct vision.

Transforming Truck Cabs

Status Quo
Truck Cab



Peep window:

Sloped hood:

Cab forward:

Incremental
improvements

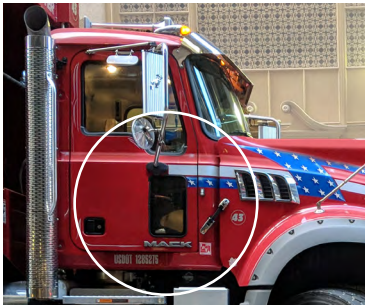

Low-entry, high-vision truck cab:

Transformative
improvement



Figure 19: Progression from a low vision truck cab to a high-vision truck cab can be incremental or transformative. Image adapted by NACTO

Availability across truck original equipment manufacturers (OEMs) affects which of these strategies can be implemented by cities. Virtually all OEMs offer sloped hoods and peep window options, most OEMs offer cab-over models, and a growing number are offering low-entry cab-over models with superior direct vision. Low-entry, high vision cab-over models are still primarily marketed to the refuse truck market, but they can be used in many other freight, construction, and special applications as well, e.g. the municipal dump truck in the rightmost panel of Figure 27. At least within the Mack lineup, cab-over models can cost about \$10,000 more than conventional cab counterparts.⁵⁷ For a \$200,000 new concrete truck or a \$250,000 new refuse truck,⁵⁸ this represents four to five percent of the total purchase cost.

A city can incorporate any of these specifications in new vehicle purchases relatively quickly and replace priority vehicles within 3-5 years. Vehicle turnover and phasing in high-vision cabs may take 7-15 years for an entire fleet.

While the maximum benefit may be achieved through procurement of new high-vision cab trucks, agencies can also take an incremental approach to improve direct vision for their existing vehicles and to reduce blind spots on new trucks with low or no additional cost.

How can workplace safety be improved through Direct Vision tools like low-entry, cab-over-engine models?

As raised by members of the Working Group, truck drivers may be supportive of low-entry cab-over trucks due to their potential for reducing workplace injury when entering and exiting the cab. In 2015, the U.S. transportation and warehousing industry had 19,940 non-fatal and 34 fatal falls, slips, or trips.⁵⁹ The lower the cab, the safer it can be for the worker who needs to climb in and out (e.g. for garbage, pothole/sidewalk repair, tree watering, oil/gas delivery, etc.).

The difference between two steps and four steps can mean more injuries and workers' compensation costs. In a Washington State study⁶⁰ of the state's 48,000 trucking workers, falls on ingress and egress of the vehicle accounted for 8 percent of all lost work time claims, or 400,000 lost workdays. Yet only about 6 percent of refuse truck claims and only about 3 percent of courier messenger claims were due to falls from vehicles in the Washington State study.⁶¹ Since refuse trucks and courier step vans typically have lower cab heights than general freight trucks, these findings demonstrate that in addition to improving direct vision for pedestrian safety, lower cab height may improve truck operator safety. Newly available models with even lower entry could potentially further improve worker safety. For example, the Freightliner EconicSD's low entry has a first step 19 inches above the ground, half the first-step height of some conventional waste collection trucks, and a kneeling feature that further reduces step-in height.⁶²

What driver perceptions must be addressed to ensure smooth transition to new cabs?

Certain driver perceptions and their relative lack of familiarity with low entry cab-over trucks can also pose a barrier to embracing this type of vehicle for improved urban maneuverability and direct vision.

First, an outdated perception that cab-overs are less safe than conventional cabs persists among some truck drivers. Driver safety concerns about cab-over trucks trace back to discontinued vehicle designs from the 1970s-80s; improvements since the 1990s have essentially closed this safety gap with conventional trucks, making cab-over trucks statistically as safe for their drivers, while potentially safer for other motorists and vulnerable road users around them.

However, over these same decades, cab-over trucks became ten times less common in the U.S.—declining from about 50 percent of all trucks to only about 5 percent.⁶³ This may explain why the negative perception has persisted. Appendix B summarizes safety data that challenge this negative perception.

Second, driver comfort and in-cab features have tended to lag in cab-over truck models over the years compared to conventional trucks, so drivers have come to associate cab-overs with less comfort.⁶⁴ However, there is no reason this has to be the case, and it appears that any remaining cab-over comfort gap is on its way to being closed with more recent manufacturer offerings.⁶⁵ Cities and other fleet customers can also demand superior comfort and features, especially as European high-vision cabs bring increased competition to the U.S. market.

Third, drivers' perceptions of low-entry, high-vision cab-overs can be colored by an association with refuse trucks, the industry in which the design is most commonly found today. In a study by Transport for London, some drivers reported feeling this stigma when first presented with a low-entry, high-vision cab. But once they had an opportunity to drive the high-vision truck themselves and to experience the improved confidence of driving it on crowded city streets, drivers reported they did not want to return to trucks with less direct vision.⁶⁶

Addressing driver culture and perception may take time but is critical to successful implementation of the high-vision truck cabs that could potentially provide the greatest safety benefit for people walking and biking nearby. Countering outdated driver perceptions of cab-overs with fact and emphasizing driver benefits such as improved workplace safety and situational awareness may be important parts of any effort to change perceptions. But based on TfL's experience, piloting these vehicles and encouraging hands-on experience may go the furthest to encouraging acceptance and smoothing implementation.

How will they assess claims about the degree of vision possible?

In the U.S. there are no regulations or standards for manufacturer claims about degree of direct vision. Thus, the only data available to U.S. fleet purchasers to help identify best-in-class direct vision truck models is generally proprietary, sales-oriented comparisons published by various OEMs. To quote one city fleet agency that Volpe interviewed, "Any OEM that we ask will tell us their cabs are high-vision." Volpe is not aware of any third-party, independent organizations that currently characterize and publish field-of-view comparisons. In the absence of objective criteria or standards for direct vision, even truck fleets that operate in dense cities do not appear to consistently purchase and dispatch trucks that minimize blind spots. Driver preference is a major influence for which models are purchased and used.⁶⁷

In 2016 Transport for London developed a Direct Vision Standard (DVS), which assesses and rates how much a truck driver can see directly from their cab in relation to other road users, because no such standard existed. The European Union now appears likely to develop a continental standard based on the DVS in the coming decade. Thus the DVS may be a starting point for U.S. efforts to characterize direct vision.

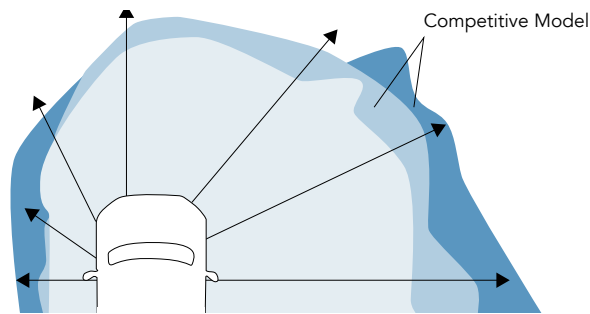

Figure 20: Example of a proprietary direct vision comparison between truck competitors. Reference: Freightliner.

As an initial U.S. effort, a low-cost, independent direct vision measurement system was recently developed and demonstrated by the Franklin W. Olin College of Engineering, with oversight from Volpe, the Working Group, the Santos Family Foundation for Traffic Safety, and other stakeholders. The Visibility in Elevated Wide vehicles (VIEW) method relies on a low-cost, app-based analysis of panoramic photos that anyone can collect from the driver's seat of a vehicle of interest, using a standard smartphone and a low-cost camera stand. The user uploads the panoramic photo to a website and enters four measurements to calculate the blind volume/visible volume rating, as shown in Figure 29. The team has developed a prototype database⁶⁸ to upload and freely access crowdsourced direct vision ratings of large vehicles by Vehicle ID Number, make, model, and weight class. As the number of entries grows, the online database will be more comprehensive and accurate for comparing the direct vision ratings of U.S. vehicle makes and models that a fleet may be considering. The Working Group can choose to pilot, improve, and leverage this methodology to inform future city vehicle procurement.



Figure 21: Comparing direct vision of a cabover and conventional cab truck using the VIEW method.

Implementation Examples

Downsizing and direct vision technologies are increasingly common, especially in Europe. The domestic and international examples of vehicle downsizing, high-vision/low-cab, window enhancements, and cab-over-engine designs deployed on trucks are provided below to illustrate how some public and private fleets are rolling out these safety strategies.

Downsizing Examples

Key to vehicle downsizing is to think holistically both about what capacity is needed and whether employing other operational practices can allow for the use of different or smaller vehicles. Many cities have found that vehicle downsizing in the context of upgrades to operational practices have resulted in a net increase in performance. Examples include:

- ▶ San Francisco, CA developed and implemented a Vision Zero specification for new “triple combination pumper” trucks operating in Chinatown and other dense neighborhoods of the city. The specification includes a shorter wheelbase, narrower width, 24 percent tighter turn radius, increased and non-tinted glazing, and flush roll-up doors.⁶⁹
- ▶ Austin-Travis County EMS in Texas⁷⁰ and Daytona Beach Fire Rescue in Florida are using motorcycles to supplement or in lieu of full-size fire and ambulance trucks for medical calls. The Daytona Beach program started in 1994 and has reduced response times from 8-10 minutes with fire apparatus to 2-3 minutes with motorcycles.⁷¹
- ▶ Philadelphia, PA, Las Vegas, NV, Cambridge, MA, and other cities have deployed bicycle EMS units in downtown districts and during large events to further decrease response times for medical emergencies.
- ▶ Somerville, MA uses a compact Hino cab-over refuse truck platform for municipal building, park, and litter basket collection.
- ▶ Houston Waste Management deployed German-produced Rotopress refuse trucks with 40 percent larger capacity and 40 percent smaller turn radius than a rigid refuse truck.⁷²



Figure 22: Houston Waste Management deployed German-produced Rotopress refuse trucks with 40 percent larger capacity and 40 percent smaller turn radius than a rigid refuse truck.



Figure 23: The Magirus 32L-AS articulated turn-table ladder truck.



Figure 24: The compact Hino cab-over refuse truck used by Somerville (MA).



Figure 25: Bicycle EMTs in Philadelphia, PA

Direct Vision Examples

Blind spot-reducing features, including peep windows, sloped-hood conventional cabs, and low-entry cab-over models have all been implemented on many private and public sector fleets across the U.S. For example:

- ▶ New York City's Safe Fleet Transition Plan⁷³ prioritizes high-vision cabs as an available safety strategy.
- ▶ NYC Department of Sanitation, Waste Management, Republic Services, and other refuse fleets extensively use low-entry cab-over models such as the Mack LR.
- ▶ San Francisco Fire Department's new pumper truck incorporates increased glazing with no tinting to improve eye contact with pedestrians and cyclists.
- ▶ Recology's Bay Area refuse and recycling fleet utilizes almost exclusively low-entry, higher-vision cabs.
- ▶ Boston Sand and Gravel Company operates a large number of Mack MR cab-over cement mixers on urban construction sites.
- ▶ Internationally, based on the Transport for London direct vision standard, the European Commission has proposed to legislate "Truck and Bus Front End Direct Vision" on new trucks and buses in the EU starting in 2028.⁷⁴ Major work truck and urban delivery fleets across Europe are increasingly deploying high-vision cabs, such as Veolia's utility fleet⁷⁵ and CEMEX's concrete mixer and dump truck fleet.⁷⁶



Figure 26: The Mack LR high-vision waste management truck used by NYC Department of Sanitation. Photo attribute: Seth Granville



Figure 27: A high-vision waste management truck used by Recology San Mateo, CA



Figure 28: The Mercedes Benz Econic cement mixer deployed by UK construction firm Tarmac



Figure 29: In-door peep windows on a UPS truck in New York City



Figure 30: Peeper windows and increased visibility doors can be retrofit into existing vehicles. New York City Metropolitan Transit Agency, New York, NY

New Availability in U.S. Markets

Notably, the Mercedes-Benz Econic high-vision trucks used in Europe became available for the first time in the U.S. in summer 2018, rebranded as the Freightliner EconicSD,⁷⁷ and Dennis Eagle announced its 2019 introduction of the ProView high-vision truck to the U.S.⁷⁸ While both are marketed to the refuse truck industry, these high-vision models can and are being used for many other applications as well, including dump trucks, refrigerated boxes, tankers, cement mixers, and even tractor trailers for urban distribution.⁷⁹



Figure 31: The Freightliner EconicSD



Figure 32: The Dennis Eagle ProView

Appendices

Appendix A: Project Scope and Structure

Appendix B: Cab-over safety data versus perceptions

Appendix C: Turn radius vehicle geometry factors

Appendix D: Figures

Appendix E: References & Citations

Appendix A:

Project Scope and Structure

To better understand the opportunities for large vehicle redesign to improve safety outcomes on urban streets, the National Association of City Transportation Officials (NACTO) partnered with the United States Department of Transportation (USDOT) John A. Volpe National Transportation Systems Center (Volpe) to convene the Vision Zero Vehicle Safety Technology Working Group (Working Group). Two companion reports, “Optimizing Large Vehicles for Urban Environments: Downsizing” and “Optimizing Large Vehicles for Urban Environments: Advanced Driver Assistance Systems” are the work products of that Working Group.

The purpose of the Working Group was to identify vehicle-based safety technology priorities, support Volpe in the development of actionable best practices, and inform an implementation roadmap for the Working Group member cities. The Working Group focused on two technology themes and developed a best practice for each.

The first theme, vehicle downsizing, was explored as a long-term strategy and included a preliminary capacity analysis comparing conventional U.S. fire trucks and commercial freight vehicles with similar vehicles in Europe and Asia. Volpe focused its best practice research a short-term, often retrofitable option within the broad topic of vehicle downsizing: blind spot reductions through direct vision improvements to the truck cab. Including direct vision, the design technologies explored by the Working Group include:

- ▶ [Direct vision improvements/high-vision cabs,](#)
- ▶ [Reduced wheelbase/turn radius \(may result in reduced weight\), and](#)
- ▶ [Curtain-side loading/unloading.](#)

In the second theme, advanced driver assistance systems (ADAS), Volpe focused best practice research into two near-term technologies for reducing vehicle stopping times: forward collision warning (FCW) and automatic emergency braking (AEB). Since 1995, the National Transportation Safety Board (NTSB) has annually published the “Most Wanted List of Transportation Safety Improvements” to advocate for safety technologies. The 2017-2018 Most Wanted List marked the second consecutive year that the agency recommended increased implementation of collision avoidance technologies, including forward collision warning systems, automatic emergency braking, adaptive cruise control and lane departure warning systems.⁸⁰ NTSB called for commercial vehicle operators to install forward collision warning systems at a minimum. Including FCW and AEB, the technologies explored by the Working Group include:

- ▶ Driver alerts:
 - ▶ [Blind spot monitoring](#)
 - ▶ [Forward collision warning](#)
 - ▶ [Lane departure warning](#)
 - ▶ [Smart detection cameras](#)
- ▶ Closed-loop automatic driving systems:
 - ▶ [Adaptive cruise control](#)
 - ▶ [Automatic emergency braking](#)
 - ▶ [Lane centering](#)

Defining the Scope:

In selecting themes and best practices, the Working Group looked to for opportunities that met a short list of criteria with clear fatality reduction benefits. In short, the Working Group focused on technologies that could:

- ▶ Improve both crash avoidance and crash mitigation capabilities (e.g. by improving drivers' situational awareness and reducing reaction time)
- ▶ Represent a mix of short- and long-term implementation strategies
- ▶ Represent a mix of open-loop, closed-loop, and/or passive technologies
- ▶ Require minimal additional driver training

In particular, technologies that could address both crash avoidance and crash mitigation were particularly of interest because they are the fundamental strategies to improving the safety of heavy-duty vehicles operating in dense urban environments. Crash avoidance can be achieved through infrastructure changes, road user education, improved situational awareness, and reduced reaction time. Crash mitigation, meanwhile, represents the last line of defense in situations in which a crash is not avoided, and is intended to reduce the severity of crashes, primarily by redirecting road users away from critical danger points (e.g., as with side underride guards and wheel guards) or reducing the speed and therefore force of impact (e.g., as with automatic braking). Given that heavy-duty vehicles are less maneuverable and take longer to stop than light-duty vehicles, reduced driver reaction time was an important criterion for selecting a focus technology.

Exploring technologies with both shorter- and longer-term implementation timelines was intended to give Working Group members flexibility in considering technologies and practices that are responsive to their unique contexts and priorities. Finally, it was important to balance the implications of technology complexity: open-loop technologies (advisory to a human who must take action) are currently more available, while closed-loop technologies (automated without a human taking action) can be less susceptible to driver error and may require less driver training. More advanced automation technology (sometimes referred to as "driverless" vehicles) is still likely a decade or more from large-scale availability, especially in more complex urban environments, and was therefore not a Working Group focus for this study.

About the Working Group:

The Working Group met approximately bimonthly over the course of one year and is scheduled to conclude in fall 2018. At the time of the project kickoff in September 2017, the member cities included the following:

- ▶ Boston, Massachusetts
- ▶ Chicago, Illinois
- ▶ Los Angeles, California
- ▶ San Francisco, California
- ▶ Seattle, Washington
- ▶ Washington, District of Columbia

Appendix B: Cab-Over Safety Data Versus Perceptions

Driver input is strongly considered by fleets when purchasing vehicles. There persists a perception of reduced rear-end crash safety for cab-overs, as well as a general unfamiliarity with them for some U.S. truck drivers. This may be largely due to lack of familiarity by newer drivers, but for more experienced drivers it may be related to recalling an actual safety gap that existed over a generation ago.

A 1991 Michigan TRI study compared crash safety for conventional vs. cab-over trucks.⁸¹ In fatal frontal impacts the percentage of ejected drivers was 50 percent higher for cab-over styles. For restrained drivers in severe impacts, the probability of injury was 20 percent higher in a cab-over compared to a conventional cab, and probability of fatality was 40 percent higher. This was all using the Trucks Involved in Fatal Accidents (TIFA) files compiled by the Center for National Truck Statistics at TRI. According to NTSB information 20 percent of cab-overs had sufficient survival space, compared to 35 percent of conventional cab tractors. It showed that cab-over tractors had higher incidence of ejection and higher injury level for non-ejection. Notably, the share of cab-over trucks on the road declined significantly (from around 40% in 1980 to around 5% in 2010) since deregulation of truck size in 1982.⁸²

However, recent U.S. cab-over v. conventional fatality statistics, taken from UM's TIFA, show the cab-over trucks have gotten markedly safer. In 2015, the fatality percentages in conventional cab tractor crashes wearing a seat belt was 10.7, vs. 12.9 for cab-over trucks. For drivers who were not wearing a seat belt, the conventional fatality percent was 58.0 vs. 60.8 percent for cab-over. Communicating to drivers that cab-over trucks are as safe as conventional trucks, while providing increased maneuverability and visibility that may help avoid crashes in the first place, may be a key strategy in adoption.

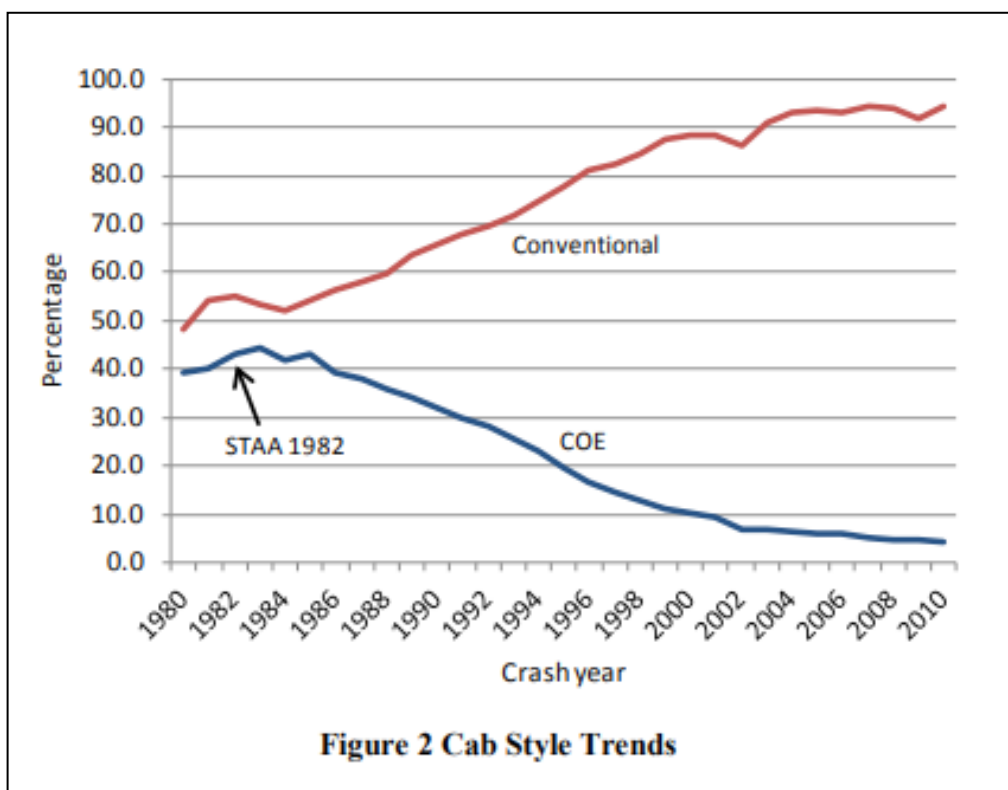

Figure 33: Cab Style Trends

Appendix C: Turn Radius Vehicle Geometry Factors

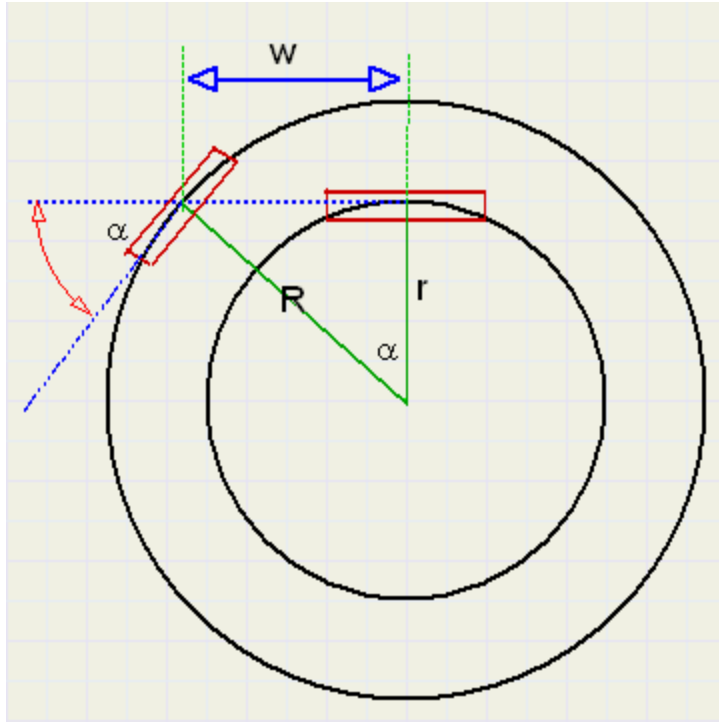

Figure 34. Inner and outer turn radius relationship to wheelbase w and wheel cut α.⁸³

Front wheel turn minimum radius $R = w/\sin \alpha$
 Rear wheel turn minimum radius $r = w/\tan \alpha$
 where w = wheelbase and α = wheel cut

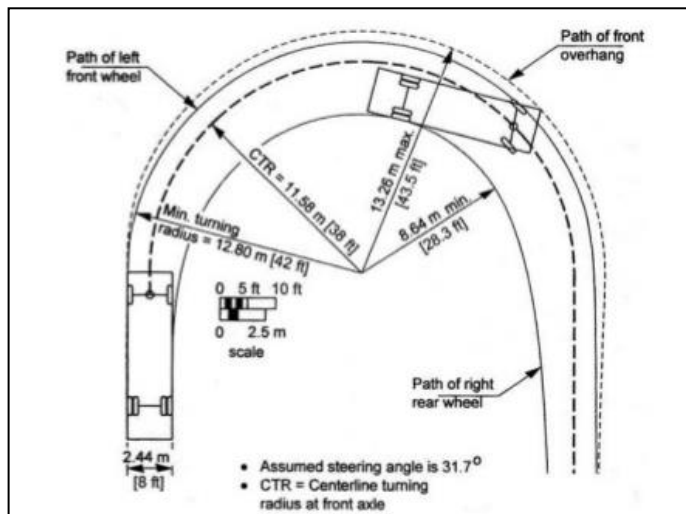

Figure 35. The swept path is the area between the paths of the left front and the right rear wheels on a turn.⁸⁴

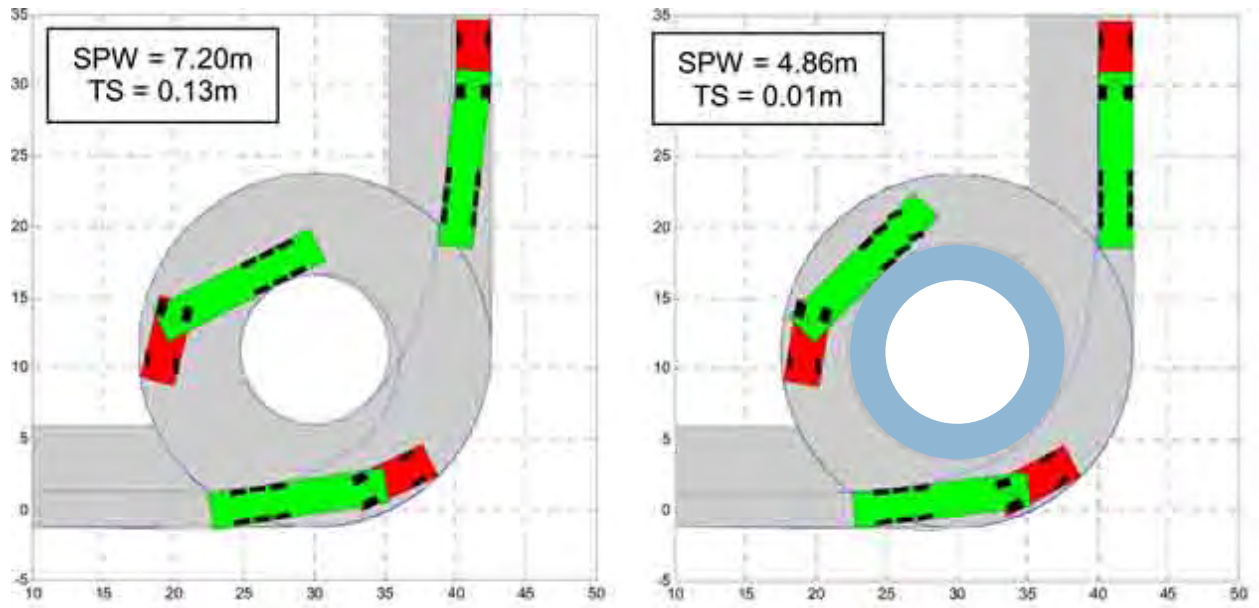

Figure 36. Reduction in swept path made possible with steerable rear axles on a trailer; the blue donut represents the area no longer mounted by the rear wheels on a turn.⁸⁵

Appendix D:

Figures

Figure 1: Response times and truck braking distance by speed and technology type	7
Figure 2: Differences in turn radii between pumper trucks.....	8
Figure 3: Ferrara Apparatus in use in San Francisco	8
Figure 4: Blindspot sizes vary by truck model and pedestrian height.....	8
Figure 5: Small changes in vehicle dimensions can reduce blindspots and space required.....	11
Figure 6: Cab-over trucks have a shorter wheelbase.....	11
Figure 7: Trucks with a tighter wheelcut also have a smaller turn diameter.....	11
Figure 8: Tag axle steering reduces turn radii.....	12
Figure 9: Low-entry cabs let drivers see adjacent people and objects.....	13
Figure 10: Mitsubishi Fuso Canter.....	13
Figure 11: Comparison of aerial ladder trucks.....	16-17
Figure 12: Comparison of pumper fire trucks.....	18
Figure 13: Comparison of commercial freight vehicles.....	19
Figure 14: High-vision cabs expand near-vehicle visibility.....	22
Figure 15: Mercedes Benz Econic MGT Euro 5 High-Vision cab.....	23
Figure 16: Comparison of sightlines from standard and high-vision cabs.....	23
Figure 17: View of a cyclist from a high-vision truck cab.....	23
Figure 18: Drivers in direct/high-vision cabs out-perform drivers in standard cabs.....	24
Figure 19: Transforming truck cabs.....	26
Figure 20: Example of proprietary direct vision model.....	29
Figure 21: Truck cab vision comparison using Olin College VIEW method.....	29
Figure 22: Rotopress refuse truck.....	30
Figure 23: Magirus 32L-AS articulated turn-table ladder truck.....	31
Figure 24: Hino cab-over refuse truck in Somerville, MA.....	31
Figure 25: Bicycle EMTs in Philadelphia, PA.....	32
Figure 26: Mack LR high-vision waste management truck in New York, NY.....	33
Figure 27: A high-vision waste management truck in San Mateo, CA.....	34
Figure 28: Mercedes Benz Econic cement mixer deployed in the UK.....	34
Figure 29: In-door peep window on a UPS truck in New York, NY.....	35
Figure 30: Retrofitted peeper windows and increased visibility doors in New York, NY.....	35
Figure 31: Freightliner EconicSD.....	36
Figure 32: Dennis Eagle Proview.....	36
Figure 33: Cab style trends (1980-2010).....	40
Figure 34: Inner and outer turn radii relationship to wheelbase and wheelcut.....	41
Figure 35: Truck swept path diagram.....	41
Figure 36: Steerable rear axles can reduce the swept path.....	42

Appendix E:

References & Citations

- 1 Bureau of Transportation Statistics, Table 1-11: Number of U.S. Aircraft, Vehicles, Vessels, and Other Conveyances. Accessed via:
<https://www.bts.gov/content/number-us-aircraft-vehicles-vessels-and-other-conveyances>
- 2 US Department of Transportation, "Large Truck and Bus Crash Facts 2016." May 2018. Accessed via: <https://www.fmcsa.dot.gov/sites/fmcsa.dot.gov/files/docs/safety/data-and-statistics/398686/tbcbf-2016-final-508c-may-2018.pdf>
- 3 National Highway Traffic Safety Administration (NHTSHA), "2017 Fatal Motor Vehicle Crashes: Overview," October 2018. Accessed via:
<https://crashstats.nhtsa.dot.gov/Api/Public/ViewPublication/812603>
- 4 National Highway Traffic Safety Administration (NHTSHA), "2017 Fatal Motor Vehicle Crashes: Overview," October 2018. Accessed via:
<https://crashstats.nhtsa.dot.gov/Api/Public/ViewPublication/812603>
- 5 National Highway Traffic Safety Administration (NHTSHA), "2017 Fatal Motor Vehicle Crashes: Overview," October 2018. Accessed via:
<https://crashstats.nhtsa.dot.gov/Api/Public/ViewPublication/812603>
- 6 National Transportation Safety Board, "Safety Study NTSB/SS-13/01: Crashes Involving Single-Unit Trucks that Resulted in Injuries and Deaths", pp 69-70 accessed via:
<https://www.nts.gov/safety/safety-studies/Documents/SS1301.pdf>;
and NTSB Safety Recommendations to NHTSA, April 3, 2014. Accessed via:
<https://www.nts.gov/safety/safety-recs/recletters/H-14-001-007.pdf>
OR
https://www.nts.gov/safety/_layouts/nts.recsearch/Recommendation.aspx?Rec=H-14-004.
- 7 Lawrence, Eric, Nathan Bomey, and Kristi Tanner. "Death on Foot: America's love of SUVs is killing pedestrians." Detroit Free Press, 1 July 2018. Accessed via:
<https://www.freep.com/story/money/cars/2018/06/28/suvs-killing-americas-pedestrians/646139002/>
- 8 For example: <https://www.cambridgema.gov/cfd/News/2018/07/emsbicycloteam.aspx>
- 9 1.8 million Class 1-5 trucks in government owned fleets versus 2.3 million commercial fleets, or 44 percent public sector share, per
<https://www.automotive-fleet.com/operations/247265/2015-fleet-vehicles-by-industry-segment>
- 10 Interview with Portland Fire Department Chief Michael Myers. April 23, 2018.
- 11 Referred to as "cramp angle" in the context of fire apparatus.
- 12 Or between the front axle and the pivot point between a double rear axle for a three-axle vehicles.
- 13 <http://www.ksde.org/Portals/0/School%20Bus/1985NCST.pdf>
- 14 Adapted from https://www.spartanchassis.com/er/er_performance.asp and https://www.isuzucv.com/en/app/site/pdf?file=ftr_brochure.pdf

- 15 By effectively reducing the wheelbase from a pivot point between the second and third axles to the second axle, making the vehicle turn as though it only had two axles.
- 16 For example: <http://www.hendrickson-intl.com/Auxiliary/Truck-Steerable-Lift-Axle>
- 17 For example MCI and Prevost buses: <http://www.mcicoach.com/service-support/serinfo/serinfo11A.htm>
- 18 For example: https://www.youtube.com/watch?time_continue=41&v=atbJsjSgJv8
- 19 Where they are referred to as “6x2 / 4” axle configurations
- 20 <https://nimbuslogistics.in/tag/steerable-axle/>; <https://www.youtube.com/watch?v=1VSVnuXCeYc>
- 21 <https://www.youtube.com/watch?v=YemYga-XufY>, https://www.youtube.com/watch?time_continue=10&v=atbJsjSgJv8
- 22 <https://nacto.org/publication/transit-street-design-guide/introduction/why/designing-move-people/>
- 23 For example, as announced by the NYC Economic Development Corporation’s Freight NYC Plan: <https://www.nycedc.com/program/freight-nyc>
- 24 <https://wktransportservices.com/en-US/blog/post/load-factor-who-is-the-most-efficient-in-europe>
- 25 Per Dr. Chris Caplice, Executive Director of the MIT Center for Transportation and Logistics in his presentation, “Forecasting Freight Transportation Rates: A Moving Target” at Volpe, August 13, 2018.
- 26 <https://www.wsj.com/articles/amazons-deal-for-whole-foods-seen-as-ideal-for-urban-pickup-and-delivery-hubs-1497700800>
- 27 Phone interview with City of Portland Fire Department Chief Michael Myers (April 23, 2018). Email from City of San Francisco Fire Department Assistant Deputy Chief Rivera (February 7, 2018)
- 28 <https://www.usfa.fema.gov/downloads/pdf/statistics/v17i8.pdf>
- 29 Fire Apparatus Manufacturers’ Association Emergency Vehicle Size and Weight Guide https://www.fama.org/wp-content/uploads/2017/12/1514564588_5a466bec19c41.pdf
- 30 https://www.fhwa.dot.gov/bridge/loadrating/fast1410_qa.pdf
- 31 Additionally, combination ladder-pumper apparatus are known as “quints,” which can be similar in size to a ladder truck. However, they are more common in rural areas than in major cities.
- 32 <https://nacto.org/wp-content/uploads/2015/04/Best-Practices-Emergency-Access-in-Healthy-Streets.pdf>; <http://www.baltimoresun.com/news/maryland/baltimore-city/bs-md-ci-fire-code-repeal-20180806-story.html>
- 33 <https://www.firerescue1.com/fire-products/fire-apparatus/articles/287182018-Rapid-response-vehicles-The-answer-to-downsizing-fire-apparatus/>
- 34 Notably, U.S. fire apparatus manufacturer Pierce introduced an “all-steer” tandem axle ladder truck in the 2000s that significantly reduced turn radius: <https://www.youtube.com/watch?v=1VSVnuXCeYc>
However, it did not catch on broadly and may have been discontinued in 2005.
- 35 26 tons versus 39.5 tons, per <https://www.fama.org/wp-content/uploads/2018/01/TC009-Em-Veh->

- [Weight-Reg-FAMA-IAFC-111122.pdf](#); Seagrave AerialScope ladder reach per phone interview with Seagrave (May 24, 2018)
- 36 <http://www.fireapparatusmagazine.com/articles/print/volume-15/issue-4/departments/keeping-it-safe/aerial-firefighter-safety-ladders-versus-platforms.html>
- 37 <https://nacto.org/wp-content/uploads/2015/04/Best-Practices-Emergency-Access-in-Healthy-Streets.pdf>
- 38 <https://nacto.org/publication/urban-bikeway-design-guide/>
- 39 Interview with David Goettee, FMCSA Research division, March 20, 2018
- 40 The forthcoming Entry Level Driver Training required to obtain a CDL will introduce minimum training requirements for the first time starting in 2020, but no minimum number of training hours. <https://www.fmcsa.dot.gov/registration/commercial-drivers-license/eldt/faqs>
- 41 Interview with David Goettee, FMCSA Research division, March 20, 2018
- 42 For example: <http://money.cnn.com/2017/08/15/technology/business/ups-virtual-reality/index.html>
- 43 <https://deepblue.lib.umich.edu/handle/2027.42/83927>
- 44 <https://www.rosopa.com/rospaweb/docs/advice-services/road-safety/cyclists/hgvs-and-vulnerable-road-users.pdf>
- 45 <https://www.polisnetwork.eu/uploads/Modules/PublicDocuments/direct-vision-evidence-from-london---hannah-white.pdf>
- 46 <http://content.tfl.gov.uk/road-safety-benefits-of-direct-vs-indirect-vision-in-hgv-cabs-technical.pdf>
- 47 https://consultations.tfl.gov.uk/roads/direct-vision-standard-phase-1/user_uploads/road-safety-benefits-of-direct-vs-indirect-vision-in-hgv-cabs-summary.pdf
- 48 https://hfast.mie.utoronto.ca/wp-content/uploads/Publications/DAddario_Pamela_M_201403_MASc_thesis_final.pdf
- 49 <http://www.clocs.org.uk/wp-content/uploads/2017/03/HANNAH-WHITE-DVS-FINAL.pdf>
- 50 See Muttart, 2003 (SAE), Muttart, 2005 (driving Assessment), as well as Fisher & Tan - These studies showed that when visual angle increased, so did reaction time. The relationship was 0.03 seconds per degree. Thus, a glance to the rearview mirror (~25 degrees), is associated with an increase in response time of near 0.7 s. This is consistent with findings by TfL: https://consultations.tfl.gov.uk/roads/direct-vision-standard-phase-1/user_uploads/road-safety-benefits-of-direct-vs-indirect-vision-in-hgv-cabs-summary.pdf
- 51 <https://phys.org/news/2017-02-larger-windscreen-lorry-safety.html#jCp>; <http://www.clocs.org.uk/wp-content/uploads/2017/03/HANNAH-WHITE-DVS-FINAL.pdf>
- 52 <http://www.government-fleet.com/channel/equipment/news/story/2010/12/milwaukee-county-uses-kenworth-t470-snowplows-to-clear-roads.aspx>
- 53 <https://www.fullyloaded.com.au/truck-reviews/0806/kenworth-t388-truck-review>
- 54 Discussion with Bill Coughlin, City of Boston

- 55 For example, the SFFD "Vision Zero" pumper truck specification.
- 56 For example: Thomas Saf-T-Liner C2 and Freightliner M2 106 (truck):
https://freightlinerads.azureedge.net/2911-m2_utility_brochure-2018-02-06.pdf
- 57 Per the McNeilus Companies, a leading refuse and cement truck manufacturer, a Mack Terra Pro or LR (cab-over) chassis costs about \$10,000 more with same performance as a Granite (conventional).
- 58 Lee, Jennifer, "Sanitation Dept. Unveils Hybrid Garbage Trucks." The New York Times, August 25, 2009. Accessed via:
<https://cityroom.blogs.nytimes.com/2009/08/25/sanitation-dept-unveils-hybrid-garbage-trucks/>
- 59 http://www.nsc.org/Membership_Site_Document_Library/2015_Injury_Facts/NSC_InjuryFacts2015Ed.pdf
- 60 <http://www.lni.wa.gov/Safety/Research/Files/Trucking/PreventingTruckingInjuries.pdf>
- 61 https://www.worksafe.qld.gov.au/_data/assets/pdf_file/0016/111283/preventing-falls-from-trucks-campaign-report.pdf
- 62 <http://www.government-fleet.com/channel/vehicle-research/news/story/2018/04/freightliner-economicsd-waste-collection-truck-unveiled.aspx>
- 63 https://www.nhtsa.gov/sites/nhtsa.dot.gov/files/812061_heavytruckinjurycountermeasures.pdf
- 64 Correspondence with McNeilus Companies
- 65 For example: <http://www.wastetodaymagazine.com/article/mack-lr-collection-truck/>
- 66 <https://www.polisnetwork.eu/uploads/Modules/PublicDocuments/direct-vision-evidence-from-london---hannah-white.pdf>
- 67 Discussions with Cemex and McNeilus
- 68 <https://blindspotcalculator.herokuapp.com/>
- 69 <https://www.wired.com/story/sanfrancisco-smaller-firetrucks/>; SFFD presentation to Working Group, January 2018
- 70 <http://www.govtech.com/public-safety/Motorcycle-Medics-Reach-the-Injured-Faster-in-Austin.html>
- 71 <http://www.codb.us/index.aspx?nid=456>
- 72 http://www.wm.com/about/press-room/2012/20120126_Rotopress.jsp
- 73 http://www.nyc.gov/html/dcas/downloads/pdf/fleet/VOLPE_Recommendations_for_Safe_Fleet_Transition_Plan_SFTP.pdf
- 74 <http://eur-lex.europa.eu/legal-content/EN/TXT/?uri=CELEX%3A52016SC0431>
- 75 <https://www.veolia.co.uk/media/media/veolia-further-advances-road-safety-through-ps5-million-investment>
- 76 <https://www.youtube.com/watch?v=ytf9BV0XgIM>
- 77 <http://www.government-fleet.com/channel/vehicle-research/news/story/2018/04/freightliner-economicsd-waste-collection-truck-unveiled.aspx>

- 78 <https://www.truckinginfo.com/288078/dennis-eagle-launches-proview-refuse-truck-in-u-s>
- 79 https://www.mercedes-benz.co.uk/content/unitedkingdom/mpc/mpc_unitedkingdom_website/en/home_mpc/truck/home/new_trucks/model_range/new-econic/new-econic/fascination/the-new-econic-from-mercedes-benz.html and <https://www.commercialmotor.com/news/mercedes-benz-new-econic-tractor-uk-time-christmas>
- 80 https://www.nts.gov/safety/mwl/Documents/MWL2016_Brochure_web.pdf and <https://www.nts.gov/safety/mwl/Documents/2017-18/MWL-Brochure2017-18.pdf>
- 81 <https://deepblue.lib.umich.edu/bitstream/handle/2027.42/907/81896a12.0001.001.pdf?sequence=2&isAllowed=y>
- 82 https://www.nhtsa.gov/sites/nhtsa.dot.gov/files/812061_heavytruckinjurycountermeasures.pdf
- 83 http://www.davdata.nl/math/turning_radius.html
- 84 Adapted from <https://www.slideshare.net/NayanaD123/ce2026-traffic-engineering-and-management-notes>
- 85 <https://nimbuslogistics.in/tag/steerable-axle/>

December 2018

DOT-VNTSC-NACTO-18-01



Prepared by
U.S.DOT Volpe Center